

**Z5372**

**T Horizontal bracket**

**Mounting instructions (1.0 EN)**

## Contents

<b>1. Product description.....</b>	<b>3</b>
Scope of supply.....	3
Technical specification.....	3
<b>2. Intended use.....</b>	<b>4</b>
<b>3. Safety precautions.....</b>	<b>4</b>
General safety.....	4
Load safety information.....	4
<b>4. Mounting options and coverage angles.....</b>	<b>4</b>
<b>5. Assembly.....</b>	<b>5</b>
Fixing to walls or ceilings.....	5
Attaching the bracket to the cabinet.....	5
<b>6. Maintenance and care.....</b>	<b>6</b>
Storing/Transport.....	6
Cleaning.....	6
Inspections.....	6
<b>7. Disposal.....</b>	<b>6</b>
<b>Manufacturer's declarations.....</b>	<b>7</b>

## General Information

Z5372 T Horizontal bracket  
Mounting instructions

Version 1.0 EN, 11/2008, D2995.EN .01

Copyright © 2008 d&b audiotechnik GmbH; all rights reserved.

Keep this manual with the product or in a safe place so that it is available for future reference.

d&b audiotechnik GmbH  
Eugen-Adolff-Strasse 134, D-71522 Backnang, Germany  
Telephone +49-7191-9669-0, Fax +49-7191-95 00 00  
E-mail: docadmin@dbaudio.com, Internet: www.dbaudio.com

# Z5372 T Horizontal bracket

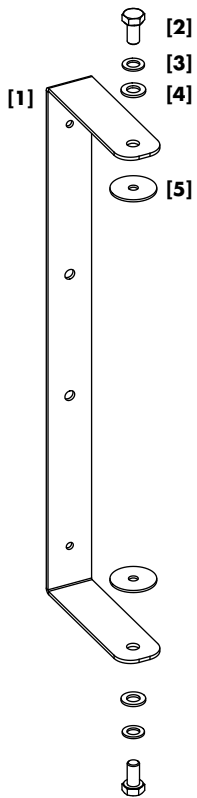

**Fig. 1: Z5372 T Horizontal bracket**

## 1. Product description

### Scope of supply

Please verify the shipment for completeness and proper condition of the items.

Qty.	d&b Code	Description
1	Z5372	T Horizontal bracket <b>[1]</b>
2		Hex head bolt M10 x 25 <b>[2]</b>
2		Spring washer <b>[3]</b>
2		U washer <b>[4]</b>
2		Rubber washer <b>[5]</b>
1	D2995.INT	Mounting instructions

### Technical specification

Weight.....0.7 kg (1.5 lb)

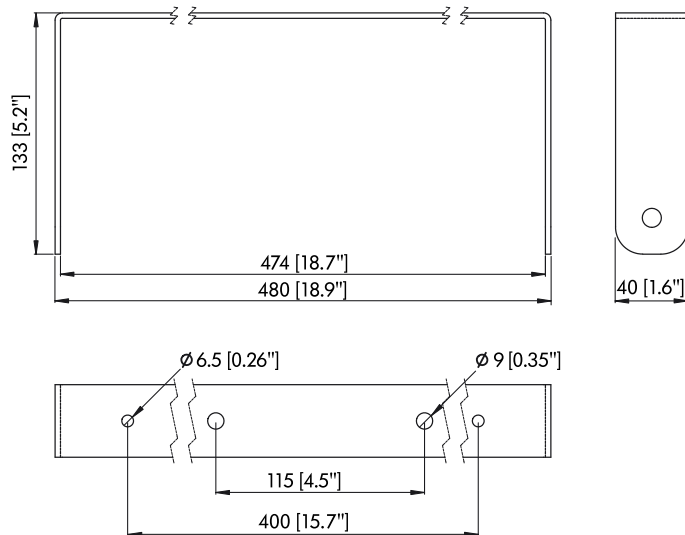

**Fig. 2: Dimensions in mm [inch]**

## 2. Intended use

The Z5372 T Horizontal bracket must only be used in conjunction with d&b T10 loudspeakers as described in these mounting instructions.

Installation and setup should only be carried out by qualified and authorized personnel observing the valid national Rules for the Prevention of Accidents (RPA).

It is the responsibility of the person installing the assembly to ensure that the suspension/fixing points are suitable for the intended use.

The bracket allows T10 loudspeaker cabinets to be mounted and set to different horizontal or vertical angles. For this purpose two inner holes 9 mm (0.35") at the d&b standard spacing of 115 mm (4.5") and two outer holes 6 mm (0.26") are provided on the tie bar of the bracket.

The bracket can be:

- directly mounted to walls or ceilings.
- horizontally flown and mounted to bars and trusses with a tube diameter of up to 50 mm (2") using the following d&b accessories:
  - Z5010, TV spigot with fixing plate
  - Z5012, Pipe clamp for TV spigot

**NOTICE:** Observe the maximum permitted load of the additional rigging accessories as stated in the respective mounting instructions.

## 3. Safety precautions

### General safety

Always carry out a visual and functional inspection of the bracket before use. In case you have any doubt as to the proper functioning and safety of the bracket, do not use it. Please also refer to section 6. Maintenance and care on page 6.

### Load safety information

The maximum permitted working load of the bracket is **11 kg (24 lb)** (according to BGV C1) which corresponds to the weight of a single T10 loudspeaker.

## 4. Mounting options and coverage angles

The two M10 threaded inserts at the top and bottom of the loudspeaker cabinet are used to attach the bracket in two different ways:

### Option 1 - Fig. 3:

Using the upper threaded inserts allows for a vertical alignment of the cabinet within an angle range of 72° (+16° to -56°).

### Option 2 - Fig. 4:

Using the bottom threaded inserts allows the cabinet to be mounted as close as possible to the respective surface e.g low height ceilings within an angle range of 9° (-5° to -14°).

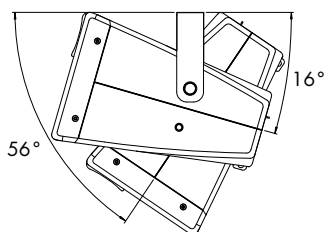

Fig. 3: Option 1

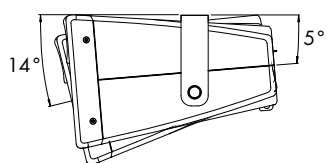
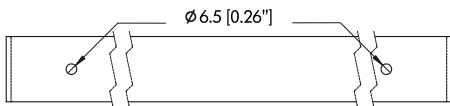
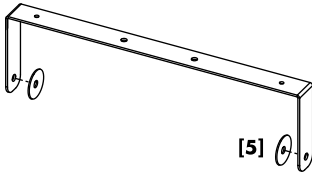

Fig. 4: Option 2



**Fig. 5: Tie bar of the bracket**



**Fig. 6: Insert rubber washers**

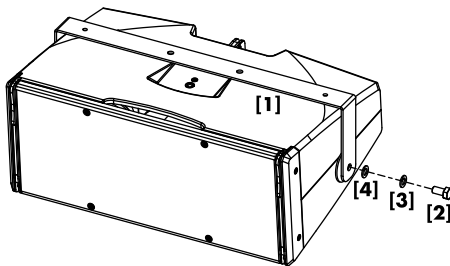

## 5. Assembly

### Fixing to walls or ceilings

**NOTICE:** Only use appropriate mounting parts (anchors and screws) that are suitable for the intended application.

Two mounting holes 6.5 mm (0.26") are provided on the back of the bracket for fixing the bracket directly to walls or ceilings or other suitable surfaces.

### Attaching the bracket to the cabinet

**NOTICE:** Only use the screws supplied and specified [2]. Always use the spring washer [3] and the U washer [4] to prevent the bolts from slackening. Ensure the two rubber washers [5] are inserted on both sides between the cabinet and the bracket.

**Tools required:** Open-end spanner/wrench (size #17).

1. Fit the cabinet to the prepared bracket.
2. Bolt the bracket to the cabinet.
3. Align the cabinet before finally tightening the screws.

## **6. Maintenance and care**

In case of mobile use of the bracket, please observe the following notes.

### **Storing/Transport**

The surface treatment temporarily protects the bracket against moisture. However, ensure the bracket is in a dry state when storing and transporting it.

During transport ensure the bracket is not stressed or damaged by mechanical forces. Use suitable transport cases.

### **Cleaning**

Regularly clean and lubricate the bracket using WD-40® or a similar product.

### **Inspections**

To eliminate the potential risk of accident due to malfunctioning of the bracket, regularly carry out a visual and functional inspection of the bracket.

If the bracket fails to operate correctly and/or safely, it must be withdrawn from use immediately.

Carry out a visual inspection of the bracket for obvious deformation and damage (e.g. cracks and corrosion).

## **7. Disposal**

Please dispose of this product in accordance with the respective national regulations.

Ensure that damaged rigging components are disposed of so that they cannot be used again.

## Manufacturer's declarations

### EC Declaration of conformity

within the meaning of the EC Machine Directive 98/37/EEC.

We hereby declare that the equipment designated below is designed and built in the version sold by us in such a way as to comply with the relevant fundamental safety and health criteria of the applicable EC Directive(s). This declaration shall cease to be valid if alterations are made to the equipment without our prior agreement.

### This declarations covers:

#### **d&b T Horizontal bracket, Z5372**

To be used as described in these mounting instructions.

### National standards and technical specifications applied:

DIN EN ISO 12100, BGV C1

Backnang, December 3, 2008



---

Frank Bothe  
Managing Director

