

DN

DN1
Manual 1.6 en



Notes on document version

All previous versions of this document are hereby no longer valid.

Version 1.6:

New feature "Factory reset" added.

Refer to:

⇒ "Factory reset" on page 11.

General information

DN1 Manual

Version: 1.6 en, 04/2025, D2759.EN .01

Copyright © 2025 by d&b audiotechnik GmbH & Co. KG; all rights reserved.

Keep this document with the product or in a safe place so that it is available for future reference.

We recommend you to regularly check the d&b website for the latest version of this document.

When reselling this product, hand over this document to the new owner.

If you supply d&b products, please draw the attention of your customers to this document. Enclose the relevant documents with the systems. If you require additional documents for this purpose, you can order them from d&b.

d&b audiotechnik GmbH & Co. KG
Eugen-Adolff-Str. 134, D-71522 Backnang, Germany
T +49-7191-9669-0, F +49-7191-95 00 00
docadmin@dbaudio.com, www.dbaudio.com

Explanation of graphical symbols



The lightning symbol within a triangle is intended to alert the user to the presence of uninsulated "dangerous voltages" within the unit's chassis that may be of sufficient magnitude to constitute a risk of electric shock to humans.



The exclamation point within a triangle is intended to alert the user to the presence of important operating and service instructions in the literature accompanying the product.



Before using this product, carefully read the applicable items of the following safety instructions.

1. Keep these instructions for future reference.
 2. Read these instructions.
 3. Heed all warnings.
 4. Follow all instructions.
 5. **WARNING!** To reduce the risk of fire or electric shock:
 - Do not expose this unit to rain or moisture.
 - Do not use this unit near water or other liquids.
 - Do not place liquid filled containers, for example beverages, on top of the unit.
 - Do not operate the unit while it is wet or standing in liquid.
 6. Always operate the unit with the chassis ground wire connected to the electrical safety earth.

Do not defeat the safety purpose of a grounding-type plug. A grounding-type plug has two blades and a third grounding prong. The third prong is provided for your safety. If the provided plug does not fit into your outlet, consult an electrician for replacement of the obsolete outlet.
 7. Do not use this unit if the power cord is damaged or frayed. Protect the power cord from being walked upon or pinched, particularly at the plugs and the point where it exits from the apparatus.
 8. The unit is intended for use in a 19" rack. Follow the mounting instructions. When a rack on wheels is used, exercise caution when moving the loaded rack to avoid injury from tipping over.
 9. Unplug this apparatus during lightning storms or when unused for long periods of time.
 10. Lay all cables connected to the unit carefully so that they cannot be crushed by vehicles or other equipment and that no one can either step on them or trip over them.
11. Refer all servicing to qualified service personnel. Servicing is required when the apparatus has been damaged in any way such as:
 - Power-supply cord or plug is damaged.
 - Liquid has been spilled into the unit.
 - An object has fallen into the unit.
 - The unit has been exposed to rain or moisture.
 - The unit does not operate normally.
 - The unit was dropped or the chassis is damaged.
 - Do not remove top or bottom covers. Removal of the covers will expose hazardous voltages. There are no user serviceable parts inside and removal may void the warranty.
 12. An experienced user must always supervise the equipment, especially if inexperienced adults or minors are using the equipment.
 13. Do not block any ventilation openings. Leave at least 5 inches of space at the front and rear of the device for proper ventilation. Remember that without proper heat dissipation and air circulation, system components might overheat, which could lead to system failure or even severely damage the components.
 14. Clean only with dry cloth.
 15. Only use attachments/ accessories specified by the manufacturer.
 16. This equipment should be installed in an area where it is unlikely for children to have access to.

1	DN1 Ethernet switch	5
1.1	Intended use.....	5
2	Scope of supply	6
3	Technical specifications	8
4	Startup	9
4.1	Overview.....	9
4.2	Rack mounting and cooling.....	9
4.3	Mains connection.....	10
4.4	Front panel.....	11
4.4.1	ETH 9 - ETH 11.....	11
4.4.2	Operating mode selection.....	11
4.4.3	LED indicators.....	13
4.5	Rear panel.....	13
5	Rack wiring diagrams	14
6	Manufacturer's declarations	15
6.1	Declaration of conformity.....	15
6.2	WEEE Declaration (Disposal).....	15
6.3	Licenses & credits.....	15
6.4	Certifications.....	15

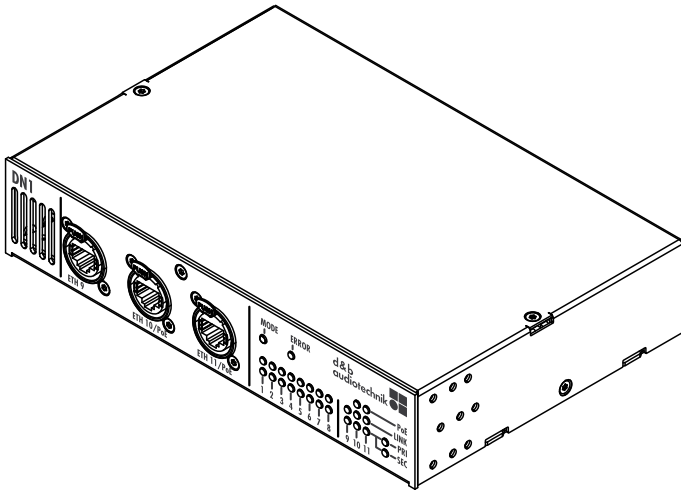

1.1 Intended use

The d&b DN1 is an AVB-enabled 11 port Ethernet switch (3 x etherCON®/8 x RJ 45).

It is mainly intended for use in the d&b Touring rack assemblies and can be configured using the d&b R1 Remote control software.

NOTICE!

The device complies with the electromagnetic compatibility requirements of EN 55032:2019 (product family standard for audio, video, audio-visual and entertainment lighting control apparatus for professional use) for the environment Class A.

Acoustic interference and malfunctions may occur if the unit is operated in the immediate vicinity of high-frequency transmitters (e.g. wireless microphones, mobile phones, etc.). Damage to the device is unlikely, but cannot be excluded.

Only shielded network cables must be used.

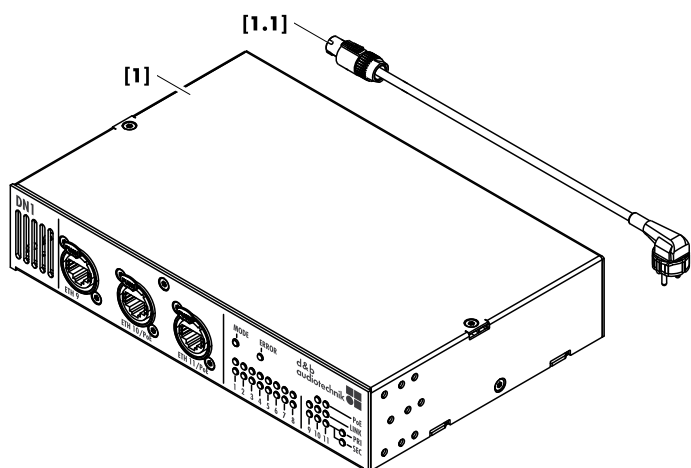

Before starting up the device, please verify the shipment for completeness and proper condition of the items.

If there is any sign of obvious damage to the unit and/or the power cord, do not operate the unit and contact your local dealer from whom you received it.

Pos.	Qty.	d&b Code	Description
[1]	1	Z4001	d&b DN1 Ethernet switch
Including:			
[1.1]	1	Z2612.xxx	Mains power cord (Specific to country*)
	1	D2759.EN .01	DN1 Manual

NOTICE!

Only use a certified mains power supply cord (2-wire + PE, minimum 1.5 mm² or AWG 16) with a voltage rating of minimum 300 V and a maximum length of 3 m (1.5 m minimum) if the power supply cord is not provided with the product.

Power cord

Only use approved mains power cords. If you have not been provided with a mains power cord for your device or for any AC powered option intended for your device, purchase a mains power cord that is approved for use in your country.

The mains power cord must be rated for the product and for the voltage and current marked on the product's electrical ratings label. The voltage and current rating of the cable should be greater than the ratings marked on the product. The mains connection towards the product should be powerCON TRUE 1 TOP type or equivalent.

* Mains plug types and associated standards

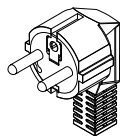

Z2612.000
3-pin Schuko
CEE 7/7

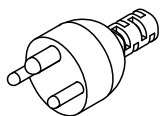

Z2612.090
3-pin Denmark
IEC 60309

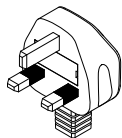

Z2612.010
3-pin GB
BS 1363A

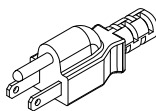

Z2612.022
3-pin USA
NEMA 5-15P

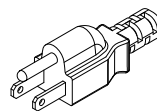

Z2612.032
3-pin Japan
NEMA L5-15P

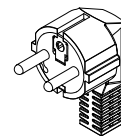

Z2612.040
3-pin South Korea
KS C8305

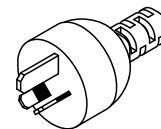

Z2612.055
3-pin Australia
AS 3112

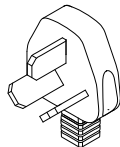

Z2612.060
3-pin China
GB 2099

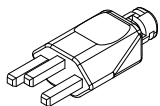

Z2612.070
3-pin Swiss
SEV1011/T23

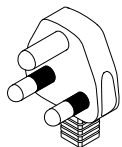

Z2612.100
3-pin South Africa
SANS 164-1

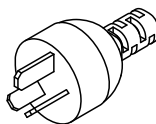

Z2612.110
3-pin Argentina
IRAM 2073

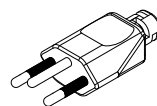

Z2612.120
3-pin Brazil
NBR 14136

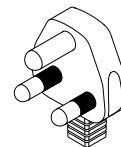

Z2612.130
3-pin India
IS 1293

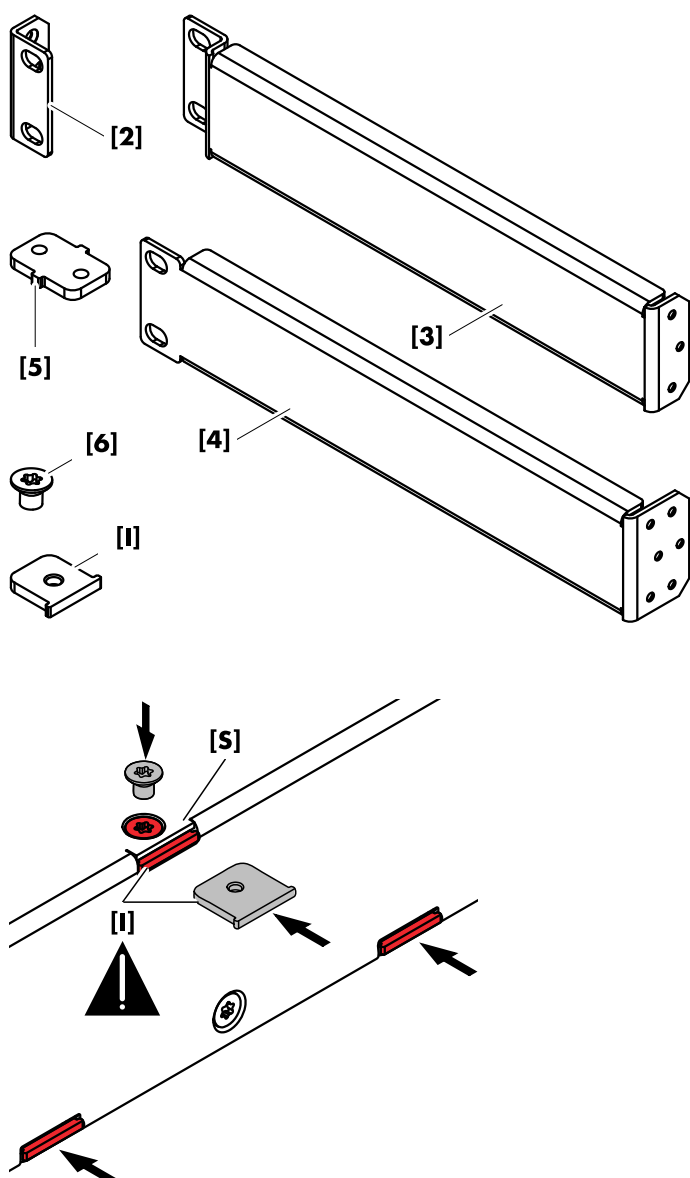

Rack mounting kits

Pos.	Qty.	d&b Code	Description
		Z2624.000	Rack mounting kit
Including:			
[2]	1	Rack ears, incl. screws M3 x 5 mm	
[3]	1	19" adapter for mobile touring racks	
[4]	1	19" adapter for installation racks	
[5]	3	Connector plates, incl. screws M3 x 4 mm	

Optionally available (spare)

		Z2624.001	Single mounting kit
Including:			
[6]	12	Countersunk screw M3 x 4 mm	
[I]	6	Cover insert	

Cover inserts

NOTICE!

The enclosure of the device provides dedicated slots **[S]** on both sides that allow two devices to be joined together side by side using the included connector plates **[5]**.

For safety reasons, these slots are protected by appropriate cover inserts **[I]** by factory default.

Under all circumstances, ensure these inserts are properly fitted at any time.

When joining two devices as described in ⇒ "Joining two devices side by side" on page 10, three of these inserts have to be exchanged with the connector plates.

However keep the removed inserts in a safe place as they must be reinserted and fixed again to restore the delivery state when separating the devices for any other intended purpose.

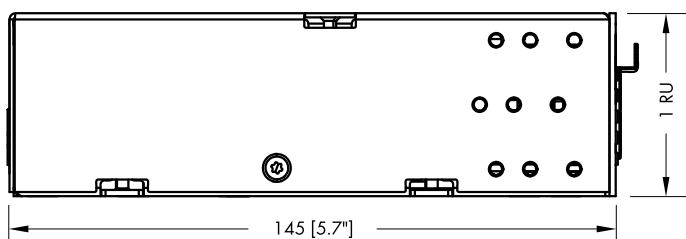

Power supply

Mains connector powerCON® TRUE 1 TOP
 Rated mains voltage 100 to 240 V, 50 - 60 Hz
 Overvoltage protection Up to 400 VAC
 Power consumption 40 W (max)

Operating conditions

Operating temperature -10 °C ... 50 °C / 14 °F ... 122 °F
 Storage temperature -20 °C ... 70 °C / -4 °F ... 158 °F
 Humidity (rel.), long term average 70%
 Operating altitude ≤ 2000 m

Network

Connectors front 3 x etherCON®
 2 x PoE ready, 15.4 W each/25 W total
 Connectors rear 8 x shielded RJ45
 Connection speed 10 Mbit/s, 100 Mbit/s, 1 Gbit/s

Controls and indicators

MODE Push button for different operating modes
 ERROR LED indicator red
 PoE LED indicator blue
 LINK LED indicator green / yellow
 AVB LED indicator red / Magenta / Cyan
 PRI / SEC LED indicator Magenta / Cyan

Dimensions and weight

Height x width x depth 1 RU x 241 mm x 145 mm
 1 RU x 9.5" x 5.7"
 Weight 1.4 kg / 3.1 lb

Rear panel connectors

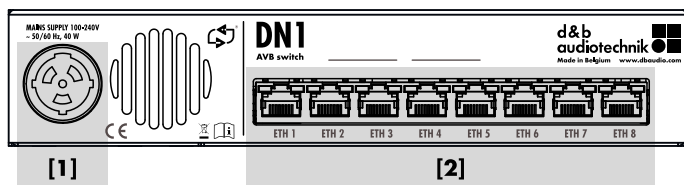

- [1] powerCON TRUE 1 TOP® mains connector socket. Refer to ⇒ Chapter 4.3 “Mains connection” on page 10.
- [2] 8 x RJ 45 ports (ETH 1 - ETH 8). Refer to ⇒ Chapter 4.5 “Rear panel” on page 13.

4.1 Overview

Front panel connectors, controls and indicators

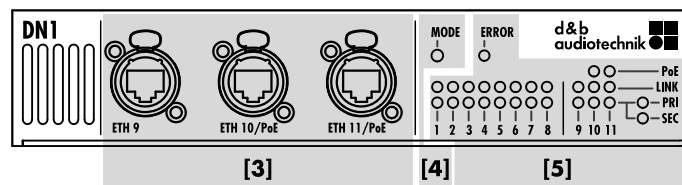

- [3] etherCON® switch ports ETH 9 - ETH 11. Refer to ⇒ Chapter 4.4.1 “ETH 9 - ETH 11” on page 11.
- [4] Mode button. Refer to ⇒ Chapter 4.4.2 “Operating mode selection” on page 11.
- [5] Multi-colored LED indicators. Refer to ⇒ Chapter 4.4.3 “LED indicators” on page 13.

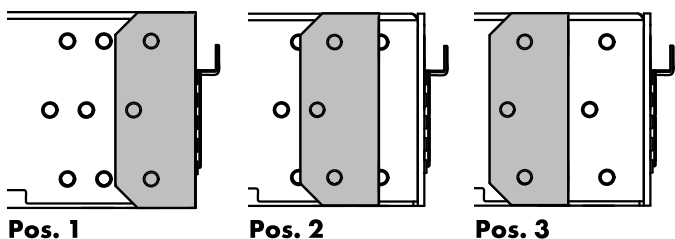

Pos. 1

Pos. 2

Pos. 3

4.2 Rack mounting and cooling

Rack mounting

The enclosure provides three different positions for the rack ears enabling different rack mounting options inside a d&b Touring rack assembly or any other rack assembly. Always mount the device with the top side facing upwards. The respective positions and their intended purposes are shown in the table below:

Note: Only use the supplied M3 x 5 mm countersunk screws, to connect the rack ears or the 19" adapter with the device.

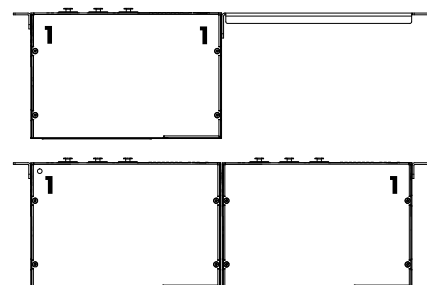

Used for installation amplifiers in combination with the 19" adapter for installation racks.

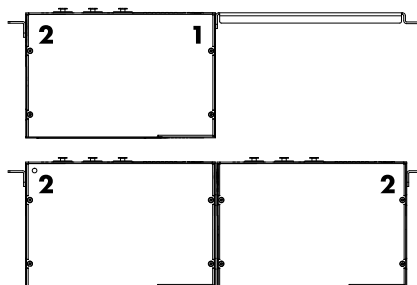

Used when mounted above the I/O panel or above a mobile amplifier and in combination with the 19" adapter for mobile touring racks.

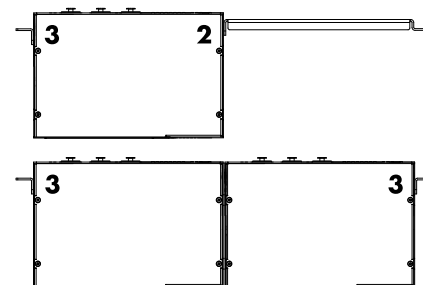

Used when mounted underneath a mobile amplifier in combination with the 19" adapter for mobile touring racks.

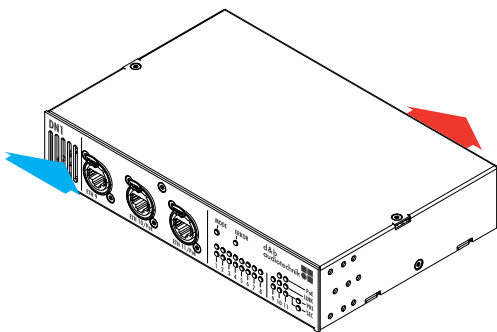
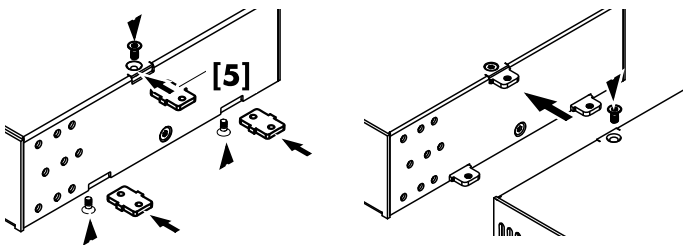
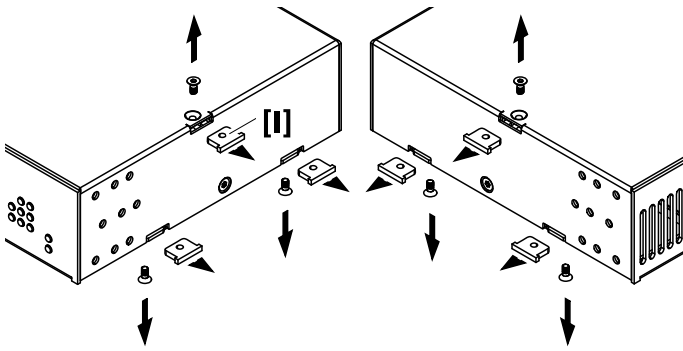

CE

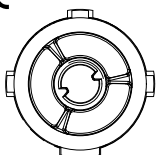

MAINS SUPPLY 100-240V
~ 50/60 Hz 40W

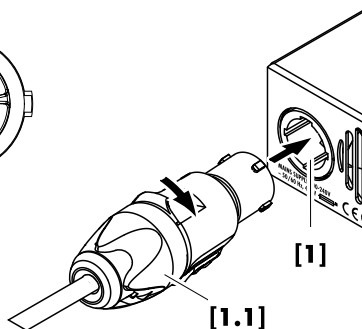

Joining two devices side by side

Two devices can be rack mounted side by side using the three connector plates [5].

To join two devices, please proceed as follows:

Tools required: Torque wrench, torx #TX10

Note:

- Please observe the safety instructions given in section ⇒ "Cover inserts" on page 7.
- Only use the supplied countersunk screws M3 x 4 mm.

1. Undo the corresponding screws on each device and remove the cover inserts [1].
2. On the first device, insert the connector plates [5] into the device and fix them using three M3 x 4 mm countersunk screws.
3. Push the second device onto the connector plates of the first device and fix them using three M3 x 4 mm countersunk screws.
4. Tighten all screws to a maximum torque of 0.8 N·m.
 - ↳ The joined devices are ready to be mounted into the respective rack using the rack ears [2].

Cooling

Thermal conditions are a vital factor to ensure operational safety of the device.

The device is equipped with an internal fan that draws cool air from the front into the housing and channels the warm air towards the back of the device.

- Please ensure that adequate cool airflow is provided.
- Do not block or cover the front panel air intake or the vent on the rear panel.

4.3 Mains connection



WARNING!

Potential risk of electric shock.

The device is a protective class 1 unit. A missing earth (ground) contact may cause dangerous voltages in the housing and controls and may lead to electric shock.

- Connect the unit to mains power supplies with protective earth only.
- If there is any sign of obvious damage to the power cord and/or mains connector, do not use the power cord and replace it before further use.
- Please ensure the mains connector is accessible at any time to disconnect the unit in case of malfunction or danger.

Before connecting the device to mains voltage, check that the mains voltage and frequency correspond to the specifications on the rating label above the mains connector socket on the rear panel of the unit.

A mains connector socket [1] is fitted on the rear panel and an appropriate power cord [1.1] is supplied.

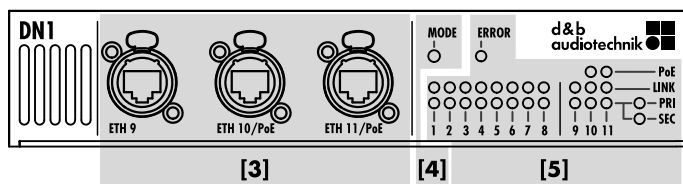

4.4 Front panel

4.4.1 ETH 9 - ETH 11

The device provides an 11-port Ethernet switch for different network topologies, redundancy (two devices) and advanced functionality with AVB. For this purpose, three connectors are provided on the front panel.

Power over Ethernet (PoE)

The «ETH 10/PoE» and «ETH 11/PoE» Ethernet connectors also provide Power over Ethernet based on IEEE standard 802.3af. Each port delivers a maximum of 15.4 W, both ports deliver a maximum total of 25 W. If the maximum power is exceeded, PoE supply will be shut off.

4.4.2 Operating mode selection

On the front panel, the device features a «MODE» button which is used for the following purposes:

- **Factory reset**
Reset the device to factory defaults maintaining remote settings.
- **Configuration mode**
Toggle between primary and secondary configurations.
- **Remote reset**
Reset all remote settings to factory defaults.
- **Wink mode** (device identification)
Visual identification of the device.

Factory reset

The factory reset function resets all device settings to factory defaults except for those affecting remote communication (dbRemoteID and IP configuration: Address, Gateway, Netmask and Mode).

To reset the device to factory defaults, proceed as follows:

1. Disconnect the device from the mains power supply.
2. Press and hold the «MODE» button, then reconnect the device to mains again.
 - ↳ All AVB port status LEDs turn red for a short period. It takes up to 20 seconds until this pattern is shown. All other LEDs are off.
3. Release the «MODE» button.
4. Within two seconds, press the «MODE» button again.
 - ↳ All AVB port status LEDs turn red for two seconds. The other LEDs are off and all settings are set to default values.

If you do not press the «MODE» button again at this point, the reset will not be performed and the LEDs will return to their normal operating behavior.

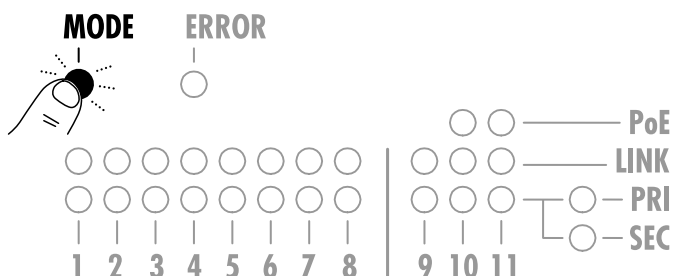

Configuration mode

If the device is operated within an AVB network, you must configure all switches for use in a primary or secondary network. The device recognizes a primary or secondary connection of the connected AVB device and indicates an error if a primary port has been connected to a secondary switch and vice versa.

Note: Without a DHCP server in LinkLocal IP mode:

- IP address range in primary mode: 169 . 254 . xxx . xxx
- IP address range in secondary mode: 172 . 31 . xxx . xxx

To enter the Configuration mode, proceed as follows:

1. Press and hold the «MODE» button for two seconds.
 - ↳ Either the «PRI» or the «SEC» LED starts to flash in periods of one second with an uptime of 50%.
2. Push the «MODE» button to toggle between primary and secondary configurations.
 - ↳ After five seconds of inactivity, the «PRI» and «SEC» LEDs leave the configuration mode and switch back to normal display mode.

Remote reset

The remote reset function resets all settings related to remote communication to factory defaults. To reset the device to factory defaults, proceed as follows:

1. During operation of the device, press and hold the «MODE» button for five seconds.
 - ↳ All AVB port status LEDs turn red for a short period. All other LEDs are off.
2. Release the «MODE» button.
3. Within two seconds, push the «MODE» button once again.
 - ↳ All AVB port status LEDs turn red for two seconds. All other LEDs are off. All remote settings are set to default values.

If you do not press the «MODE» button again at this point, the reset will not be performed and the LEDs will return to their normal operating behavior.

Wink mode (device identification)

To activate the Wink mode, proceed as follows:

- ⇒ Press the «MODE» button once.
 - ↳ All AVB port status LEDs flash in the color of the current Configuration mode (● = Primary / ● = Secondary). After three seconds, the Wink mode stops automatically.

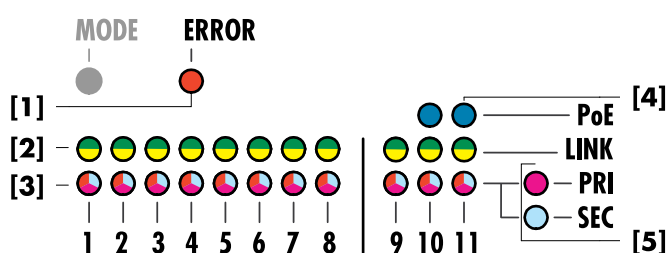

4.4.3 LED indicators

All device states and operating modes are indicated by dedicated multi-color LEDs.

Note: In case of a device error, connect the device to R1 via OCA to obtain further information.

The LED color codes and the related device states and operating modes are detailed in the table below.

LED color	[1] Error	[2] LINK	[3] AVB	[4] PoE	[5] PRI/SEC
	Device error detected.	-	Detected AVB network does not match the device settings.	-	-
	-	Network activity, max. 1 Gbit.	-	-	-
	-	Network activity, max. 100 Mbit.	-	-	-
	-	-	Primary AVB network detected.	-	Device in PRI network mode.
	-	-	Secondary AVB network detected.	-	Device in SEC network mode.
	-	-	-	Active PoE supply.	-
LED off	Normal operation.	No active connection.	No AVB network information.	No PoE enabled device connected.	-
LED flashing	-	Data traffic.	-	PoE Error.	-

4.5 Rear panel

ETH 1 - ETH 8

For the internal rack wiring, 8 x RJ 45 ports are provided at the rear of the device.

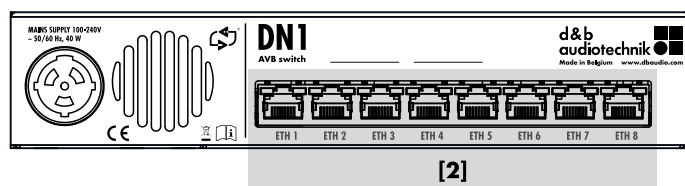

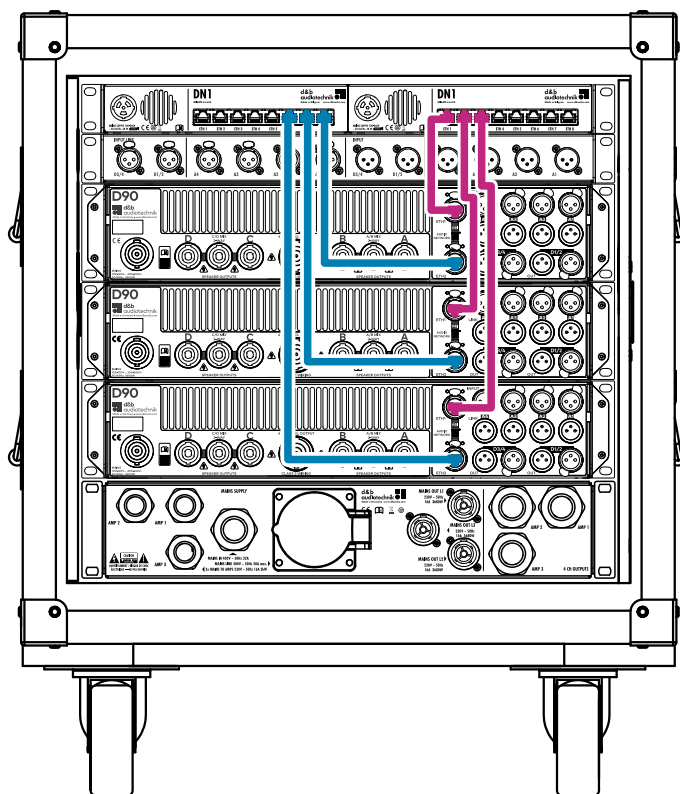
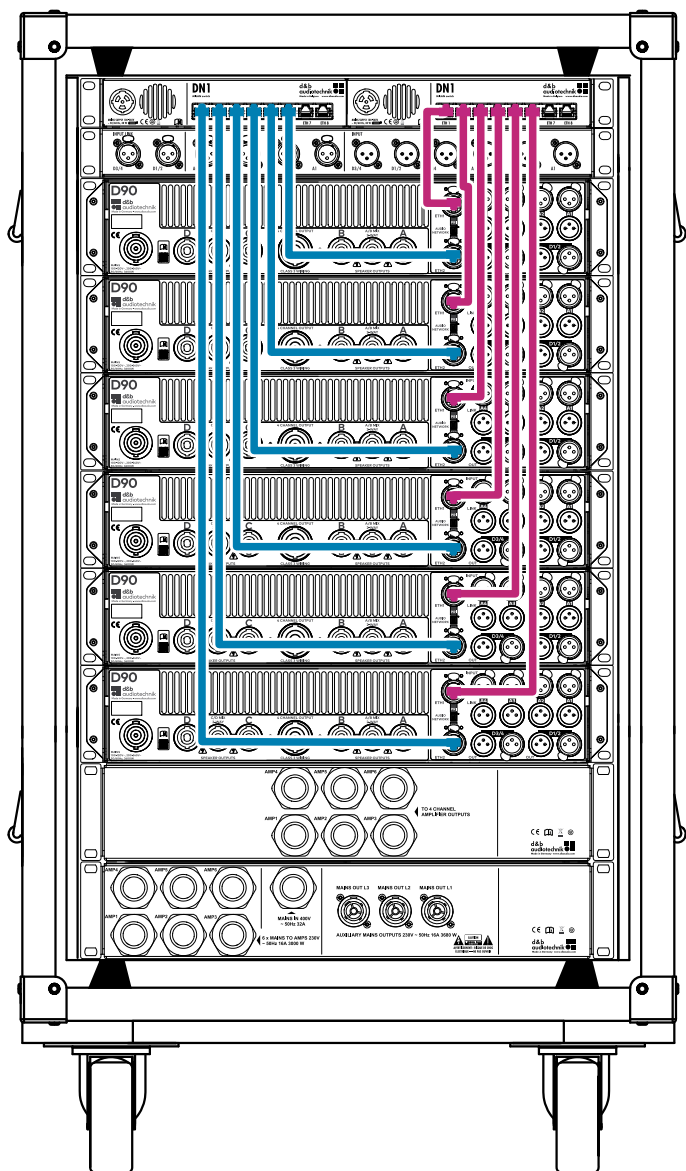



6.1 Declaration of conformity

This declaration applies to:

d&b Z4001 DN1 AVB network switch

by d&b audiotechnik GmbH & Co. KG.

All product variants are included, provided they correspond to the original technical version and have not been subject to any later design or electromechanical modifications.

We herewith declare that said products are in conformity with the provisions of the respective directives including all applicable amendments.

Detailed and applicable declarations are available on request and can be ordered from d&b or downloaded from the d&b website at www.dbaudio.com.



6.2 WEEE Declaration (Disposal)

Electrical and electronic equipment must be disposed of separately from normal waste at the end of its operational lifetime.

Please dispose of this product according to the respective national regulations or contractual agreements. If there are any further questions concerning the disposal of this product, please contact d&b audiotechnik.

WEEE-Reg. -Nr. DE: 13421928

6.3 Licenses & credits

This device uses a number of third-party libraries to provide certain features. These libraries are supplied along with the firmware of this device. For further information, please refer to the download center of the d&b website at www.dbaudio.com.



6.4 Certifications

Avnu DN1 certification

Certification ID: [223](#)

Date Certified: 2021-06-30

Supported Segments: Milan™

Product Classes: Switch

