

D6 Amplifier

Hardware manual (1.9 EN)

General Information

D6 Amplifier
Hardware manual

Version 1.9 EN, 02/2014, D2017.EN.01

Copyright © 2014 by d&b audiotechnik GmbH; all rights reserved.

Keep this manual with the product or in a safe place so that it is available for future reference.

When reselling this product, hand over this manual to the new customer.

If you supply d&b products, please draw the attention of your customers to this manual. Enclose the relevant manuals with the systems. If you require additional manuals for this purpose, you can order them from d&b.

d&b audiotechnik GmbH
Eugen-Adolff-Strasse 134, D-71522 Backnang, Germany
Telephone +49-7191-9669-0, Fax +49-7191-95 00 00
E-mail: docadmin@dbaudio.com, Internet: www.dbaudio.com

IMPORTANT SAFETY INSTRUCTIONS

Explanation of graphical symbols



The lightning symbol within a triangle is intended to alert the user to the presence of uninsulated "dangerous voltages" within the unit's chassis that may be of sufficient magnitude to constitute a risk of electric shock to humans.



The exclamation point within a triangle is intended to alert the user to the presence of important operating and service instructions in the literature accompanying the product.

Before using this product, carefully read the applicable items of the following safety instructions.

1. Keep these instructions for future reference.
2. Read these instructions.
3. Heed all warnings.
4. Follow all instructions.
5. Keep water or other liquids away from the unit. Do not place liquid filled containers, for example beverages, on top of the unit.
6. Do not operate the unit while it is wet or standing in liquid.
7. Always operate the unit with the chassis ground wire connected to the electrical safety earth. Do not defeat the safety purpose of a grounding-type plug. A grounding-type plug has two blades and a third grounding prong. The third prong is provided for your safety. If the provided plug does not fit into your outlet, consult an electrician for replacement of the obsolete outlet.
8. Do not use this unit if the power cord is damaged or frayed. Protect the power cord from being walked upon or pinched, particularly at the plugs and the point where it exits from the apparatus.
9. The unit is intended for use in a 19" rack. Follow the mounting instructions. When a rack on wheels is used, exercise caution when moving the loaded rack to avoid injury from tipping over.
10. Unplug this apparatus during lightning storms or when unused for long periods of time.
11. Never connect an output pin to any other amplifier input or output pin or to the earth (ground). This may damage the unit or lead to electric shock.
12. Lay all cables connected to the unit carefully so that they cannot be crushed by vehicles or other equipment and that no one can either step on them or trip over them.
13. Refer all servicing to qualified service personnel. Servicing is required when the apparatus has been damaged in any way such as:
 - Power-supply cord or plug is damaged.
 - Liquid has been spilled into the unit.
 - An object has fallen into the unit.
 - The unit has been exposed to rain or moisture.
 - The unit does not operate normally.
 - The unit was dropped or the chassis is damaged.
 - Do not remove top or bottom covers. Removal of the covers will expose hazardous voltages. There are no user serviceable parts inside and removal may void the warranty.
14. Use the mains plug as the disconnecting device and keep it readily accessible. If the mains plug is not readily accessible due to mounting in a 19" rack, then the mains plug for the entire rack must be readily accessible.
15. An experienced user must always supervise the equipment, especially if inexperienced adults or minors are using the equipment.

Contents

1. Introduction.....	5
1.1. Intended use.....	5
1.2. Scope of supply.....	5
1.3. Maintenance/Service.....	6
2. D6 Amplifier.....	7
2.1. D6 based systems.....	7
2.2. Block diagram.....	7
2.3. Power supply.....	8
2.3.1. Inrush current limiter.....	8
2.3.2. Mains voltage monitoring.....	8
2.4. Fan.....	8
2.5. D6 power amplifiers.....	8
2.6. Digital signal processing.....	8
2.7. Remote control.....	8
3. Controls and indicators.....	9
3.1. Controls.....	9
3.1.1. Power switch.....	9
3.1.2. MUTE A/B switch.....	9
3.1.3. LEVEL/PUSH MENU.....	10
3.2. Indicators.....	11
3.2.1. LC Display.....	11
3.2.2. ISP LED.....	11
3.2.3. GR LED.....	11
3.2.4. OVL LED.....	11
4. Connections.....	12
4.1. Mains connector.....	12
4.2. Signal inputs and link outputs.....	13
4.2.1. INPUT A/B and LINK A/B.....	13
4.2.2. INPUT DIGITAL AES/EBU and LINK.....	13
4.3. Loudspeaker output connectors - OUT A/B.....	14
4.4. REMOTE interface.....	15
4.5. SERVICE.....	15
5. Installation and operation.....	16
5.1. Rack mounting and cooling.....	16
5.2. Operation.....	17
5.2.1. Power consumption and power loss.....	17
5.2.2. Mains supply.....	18
5.2.3. Operating conditions.....	18
6. Technical specifications.....	19
6.1. Dimensions.....	21
7. Manufacturer's declarations.....	22
7.1. EU declaration of conformity (CE symbol).....	22
7.2. WEEE Declaration (Disposal).....	22

1. Introduction

This manual describes the facilities and basic functions of the hardware of the D6 amplifier. A detailed description of the D6 software (firmware) menu structure and access is given in the D6 Software manual, which is also provided with the D6.

1.1. Intended use

The D6 amplifier is a two channel power amplifier and controller unit. It is designed for use with all current d&b loudspeakers except 2-Way Active, V-Series and B2-SUB systems. A linear mode is available allowing the D6 to be used as a linear power amplifier.

NOTICE: The device complies with the electromagnetic compatibility requirements of EN 55103 (product family standard for audio, video, audio-visual and entertainment lighting control apparatus for professional use) for the environments E1 (residential), E2 (business and commercial), E3 (outdoor use in urban areas) and E4 (outdoor use in rural areas).

Acoustic interference and malfunctions may occur if the unit is operated in the immediate vicinity of high-frequency transmitters (e.g. wireless microphones, mobile phones, etc.). Damage to the unit is unlikely, but cannot be excluded.

1.2. Scope of supply

Before starting up please verify the shipment for completeness and condition of the unit:

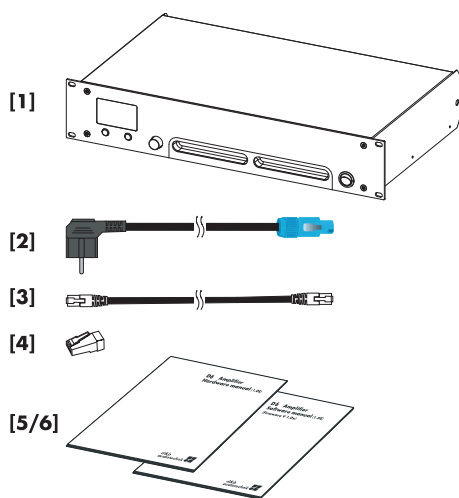

Fig. 1: D6 Amplifier, scope of supply

Quantity	d&b Code	Description
1	Z2700	D6 Amplifier [1]
1	Z2610.xxx	Power cord [2] D6 CEE (specific to country)
1	K6007.050	RJ45 Patch cable [3] 0.5 m (1.6 ft) CAT 6/AWG 24-STP (shielded twisted pair) to be used for daisy chaining multiple amplifiers within a rack.
1	Z6116	RJ 45 M Terminator [4]
1	D2017.EN	D6 Amplifier, Hardware manual [5]
1	D2018.EN	D6 Amplifier, Software manual [6]

Tab. 1: D6 Amplifier, scope of supply

If there is any sign of obvious damage to the unit and/or the power cord do not operate the unit. Please contact your local dealer from whom you received the unit.

1.3. Maintenance/Service

Do not open the unit. No user serviceable parts inside. In case of any damage do not operate the unit under any circumstances.

Refer servicing only to qualified service personnel authorized by d&b audiotechnik. In particular if:

- objects or liquids have entered the unit.
- the unit is not operating normally.
- the unit was dropped or the housing is damaged.



CAUTION!

Potential risk of explosion.

The unit incorporates a lithium battery which may cause danger of explosion if not replaced correctly.

- Refer replacement only to qualified service personnel authorized by d&b audiotechnik.
 - Only replace with the same type of battery.
-

2. D6 Amplifier



Fig. 2: D6 Amplifier

2.1. D6 based systems

The D6 Amplifier incorporates:

- universal voltage, switch mode power supply with active power factor correction (PFC)
- two channel Class D power amplifier
- digital signal processors (DSP)
- comprehensive protection circuits
- controls and indicators
- analog and digital signal inputs and link outputs
- REMOTE and SERVICE interface

The level control on the front panel incorporates a digital rotary encoder, which enables selection of all operating modes in conjunction with a Liquid Crystal Display (LCD).

User definable equalization and delay functions are incorporated in each channel of the D6. The 4-band parametric equalizer provides optional Boost/Cut or Notch filtering and the signal delay capability allows delay settings of up to 340 ms (= 100 m / 328 ft) to be applied independently to either channel. A signal generator offering pink noise or sine wave program is also incorporated for test and alignment purposes. Each unit can be given a unique Device Name to simplify identification and a password protected LOCK function is also incorporated to inhibit unauthorized set up changes.

The D6 is housed in a 19" x 351 mm (13.8") 2 rack unit enclosure made from steel.

2.2. Block diagram

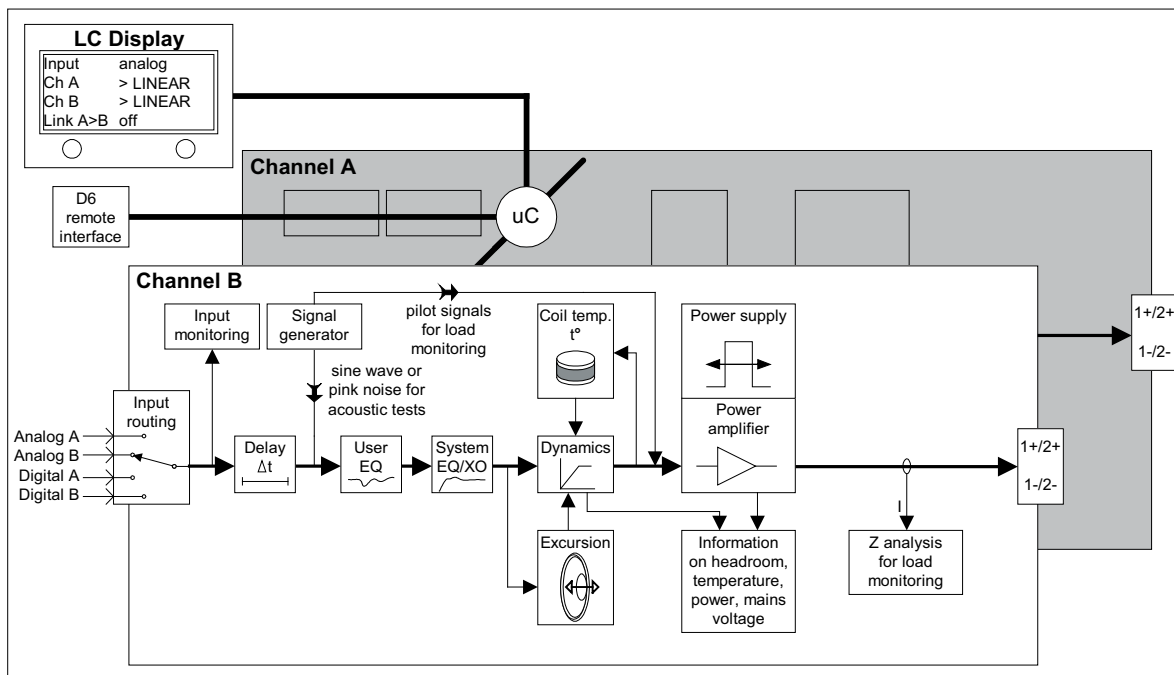

2.3. Power supply

The switch mode mains power supply permits worldwide application without the need for mains voltage switching or conversion. The power supply incorporates active Power Factor Correction (PFC) which provides a clean and highly efficient sinusoidal current draw, thus providing highest performance under adverse mains conditions or when very long power cabling is necessary.

2.3.1. Inrush current limiter

A mains inrush current limiter provides a "soft start" and enables several units to be powered up at the same time without overloading the mains power supply.

2.3.2. Mains voltage monitoring

The mains voltage and frequency are recorded by the power supply and can be viewed on the LCD display. Where voltages outside of this range are present, a self-resetting protective circuit responds quickly to isolate the internal amplifier power supply leaving only a supervisory circuit to monitor the mains voltage. The D6 accepts mains voltages of up to 400 VAC without damage to the unit.

2.4. Fan

A level and temperature controlled fan is incorporated for cooling the internal components, which allows greater cooling during louder program material. The fan speed is consequently reduced during quieter passages preventing background noise interference. If the D6 heats up a "Temp. Warning" is given out and the fan will give full cooling power permanently.

2.5. D6 power amplifiers

The two power amplifiers fitted to the D6 are utilizing Class D technology similar to a switch mode power supply. Compared to the known linear amplifier concept (Class A, AB, G or H) the Class D power amplifiers produce less heat and allow for a compact and light weight design.

The rated sine wave output power of each channel is 2 x 600 W into an 4 ohms load, decreasing to 2 x 350 W into a 8 ohms load.

2.6. Digital signal processing

The digital signal processing provides loudspeaker specific setups that are selected using the front panel controls. These setups include all loudspeaker specific equalization and protection functions. The basic latency of the D6 is 0.3 ms (analog input including AD/DA conversion).

2.7. Remote control

The REMOTE interface (2 x RJ 45) can be used with the d&b Remote network (CAN-Bus) to integrate the D6 into a control and monitoring system.

3. Controls and indicators

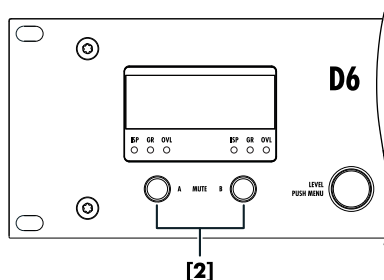
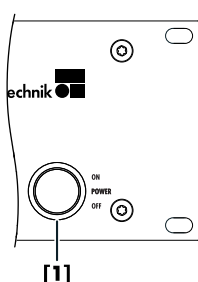
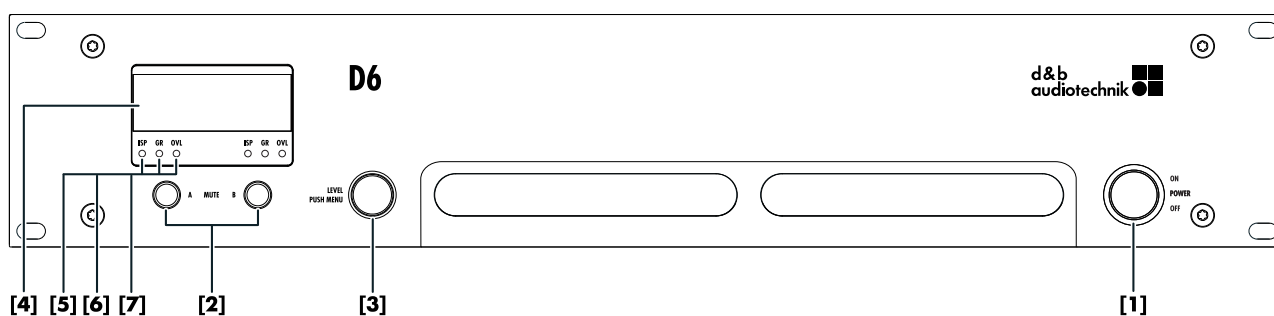

3.1. Controls

3.1.1. Power switch

The power switch [1] is a rocker switch type. It does not isolate the unit from the mains power.

- **OFF**
The unit is switched off. The power consumption is low (1 W typical).
- **ON**
The unit is switched on and ready for operation.

3.1.2. MUTE A/B switch

When the mains power switch is set to the on position, the MUTE A/B switches (push buttons) [2] can be used to mute the respective amplifier channel or place the D6 in Standby mode.

Note: The setting of the MUTE A/B switch is stored in the D6 when the mains power is turned off or disconnected. After switching on or reconnecting the unit it will revert to its previous status.

MUTE / STANDBY

- A brief press of the MUTE A or B switch will mute the corresponding channel A or B. The channel is unmuted by briefly pressing the corresponding MUTE switch.
- A longer press (approx. 1.5 s) of MUTE A or B places the D6 in Standby mode. Briefly pressing the MUTE A or B switch again powers on the D6 ready for use. The D6 may also be powered back on by remote control from Standby mode.

Status indication

The switch incorporates a green LED indicator which indicates three different states – ON, MUTE and STANDBY.

- **LED illuminates permanently** ⇒ **ON (unmuted)**

The D6 is ready for use.

- **LED regular flashing (1:1 duty cycle):** ⇒ **MUTE**

The corresponding channel of the D6 is muted however the power amplifiers remain powered but receive no signal from the controller. A connected loudspeaker is therefore still damped.

- **Regular short flashes (1:8 duty cycle):** ⇒ **STANDBY**

In Standby mode the loudspeaker outputs are electronically isolated and the D6 idles, drawing minimal mains power. Only the most essential functions are provided. Display and network remain functional, the display illumination will be switched off after 10 s.

Note: When the D6 is set to STANDBY (or the mains power is turned off) the movement of the loudspeaker cones in the cabinets connected is no longer damped by the power amplifier output. This removal of the damping makes them susceptible to excitation by other loudspeakers in the surroundings. Audible resonances may occur, and even absorption of low frequency sound energy as the undamped loudspeakers act like a "bass trap". To permanently mute single subwoofer cabinets when others are operated at the same time it is therefore preferable to use the MUTE function instead of STANDBY. The Standby mode, however, can be of advantage with mid/high systems, because it will remove any residual noise from the system.

3.1.3. LEVEL/PUSH MENU

Operation, configuration and status viewing of the D6 are all accessed via the front panel digital rotary encoder - LEVEL/PUSH MENU [3]. In the main menu the encoder acts as a level control. Pushing or turning the encoder gives access to different menu levels or enables configurations or values to be entered.

Brief press

Alternating between level control of channel A or B.

Long press (approx. 1 s)

Access to the menu level. A detailed description of the D6 menu structure and access is given in the D6 Software manual, which is also provided with the D6.

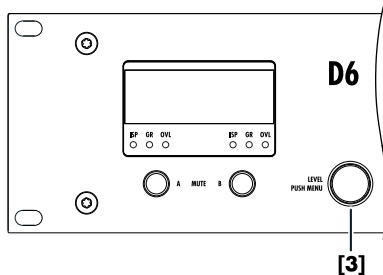

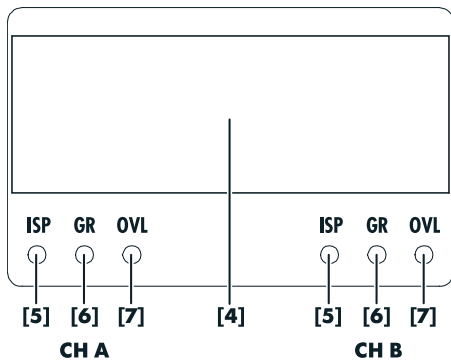

3.2. Indicators

3.2.1. LC Display

The LC Display [4] serves as a user interface and display for all configuration settings and status information.

The display is illuminated and can be set to "on/off/timeout 10 s."

A detailed description of the menu structure and access is given in the D6 Software manual, which is also provided with the D6.

3.2.2. ISP LED

The ISP LED [5] (**I**nput **S**ignal **P**resent) indication is unaffected by the setting of the level control and the MUTE function but will not operate in STANDBY mode.

The ISP LED illuminates green:

- when the analog input signal fed to the D6 **analog inputs** exceeds -30 dBu.
- when the D6 **digital input** is locked to 48 or 96 kHz and the digital signal exceeds -57 dBFS (FS = Full Scale).

3.2.3. GR LED

The GR LED [6] (**G**ain **R**eduction) illuminates yellow depending on the input signal. The D6 limiter circuit reduces gain by more than 3 dB. This state is not critical but indicates that the system has reached its limits.

3.2.4. OVL LED

The OVL LED [7] (**O**ver**L**oad) illuminates red depending on the input signal. Either the input signal level is too high or gain reduction exceeds 12 dB.

- If in doubt please reduce the input gain at the D6 level control. If caused by the gain reduction, the OVL LED stops illuminating. If the condition does not change, the input signal to the D6 is too high (greater than $+25$ dBu).

An overload could also be caused by accumulating the source input A+B or by high gain settings (boosts) in the single EQ bands, while the input signal is lower than $+25$ dBu.

Flashes (1:1 mark space) ⇒ **Error**

An error message will be displayed altering with the device name.

4. Connections

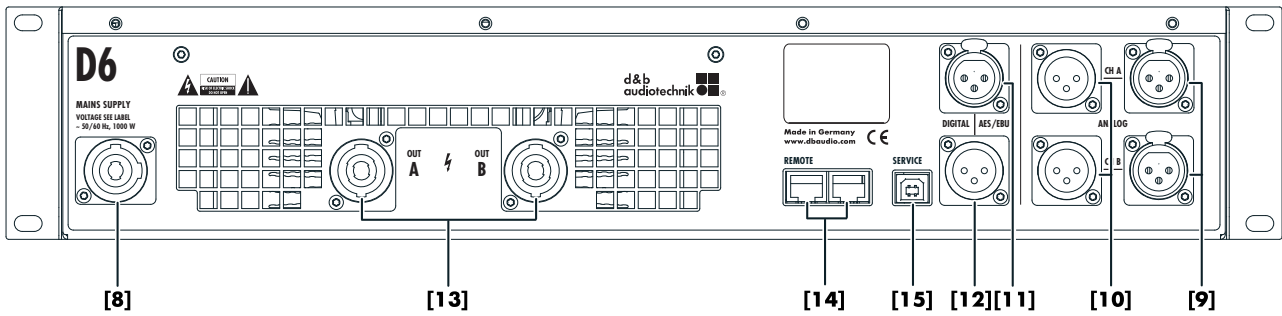

4.1. Mains connector



WARNING! Potential risk of electric shock.

The D6 is a protective class 1 unit. A missing earth (ground) contact may lead to dangerous voltages in the housing and controls, and may lead to electric shock.

- Connect the unit to mains voltage supplies with protective earth only.
- If there is any sign of obvious damage to the power cord and/or mains connector do not use the power cord and exchange it before further use of the unit.
- Please ensure the mains connector is accessible at any time to disconnect the unit in case of malfunction or danger.
- Do not disconnect the PowerCon^{®1} mains connector from the unit while it is connected to the mains voltage supply.

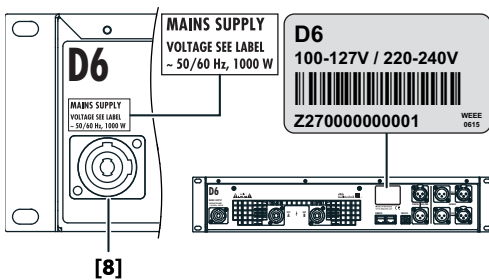

A PowerCon mains connector [8] is fitted on the rear panel and an appropriate mains lead is supplied.

Before connecting the device to mains voltage, check that the mains voltage and frequency correspond to the specifications on the configuration sticker on the rear of the D6.

¹ PowerCon[®] is a registered trademark of the Neutrik AG, Liechtenstein

4.2. Signal inputs and link outputs

NOTICE: To meet the EMC requirements only use shielded cabling and properly fitted connectors.

4.2.1. INPUT A/B and LINK A/B

A 3 pin female XLR input connector [9] is provided for channel A and B. The inputs are electronically balanced.

Wired in parallel is a 3 pin male XLR input link connector [10] used to feed the input signal on to the next device in the system signal chain.

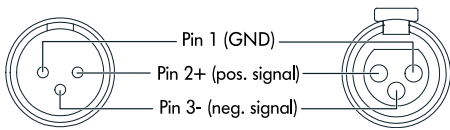

Fig. 3: Pin assignment ANALOG INPUT/LINK

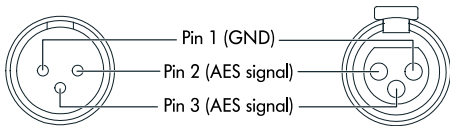

Fig. 4: Pin assignment DIGITAL INPUT/LINK

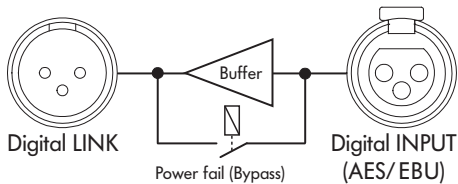

Fig. 5: Digital INPUT Bypass

4.2.2. INPUT DIGITAL AES/EBU and LINK

A 3 pin female XLR AES/EBU [11] (AES 3) input and a 3 pin male XLR LINK output [12] are provided.

The balanced input utilizes a transformer and is electrically isolated.

The digital LINK output may be used to feed a refreshed input signal to the next device in the system signal chain. The signal shape (the rising and trailing edges of the signal) and level are refreshed with an analog signal amplifier.

A power fail relay is incorporated to prevent interruption of the signal chain should there be a power failure. In this situation, the digital input signal bypasses the analog buffer amplifier and is routed directly to the LINK output.

4.3. Loudspeaker output connectors - OUT A/B



WARNING! Potential risk of electric shock.

The amplifier's output pins can carry dangerous voltages.

- Only use isolated loudspeaker cables with correctly fitted connectors.
- Never connect an amplifier output pin to any other input or output connector pin or protective earth (ground).

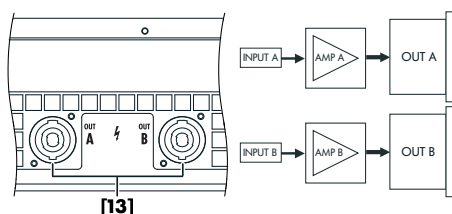

[13]

Fig. 6: NL4 Loudspeaker output connectors and channel assignment

The D6 amplifier is supplied with NL4 output connectors [13]. Pins 1+/2+ and 1-/2- are wired in parallel and carry signal.

Pin equivalents of the amplifier's output connectors and the type of loudspeaker cabinets are listed in the table below.

D6 Output	NL4
+	1 + / 2 +
-	1 - / 2 -

Tab. 2: D6 pin assignment

Speaker type	NL4
TOP +	1 +
TOP -	1 -
SUB +	2 +
SUB -	2 -

Tab. 3: Pin assignment loudspeaker

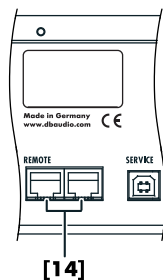

4.4. REMOTE interface

The D6 is fitted with a 2-wire serial remote control interface, (2 x RJ 45 [14]) carrying CAN-Bus signals.

All pins of both connectors are wired in parallel allowing either to be used as the input or output. Where remote control networking conforms to a "Bus or Ring topology" one connector is used for the incoming signal and the second connector allows for direct connection to another device (daisy chaining) or for terminating the last device at the end of a CAN-Bus segment.

The reference ground of the CAN-Bus is hard wired to common ground (protective earth) of the device.

Pin	Signal	Remark
1	-	
2	-	
3	-	
4	CAN_H	"CAN high bus" signal (active high)
5	CAN_L	"CAN low bus" signal (active low)
6	-	
7	-	
8	-	
Enclosure	GND	CAN Ground

The "CAN Ground" is routed via the cable shielding. Within the CAN-Bus network, shielded cables and shielded RJ 45 connectors must be used while the cable shielding must be connected to both sides of the RJ 45 connector.

A detailed description of remote control via the d&b Remote network (CAN-Bus) is given in the technical information TI 312 (d&b code D5312.E.) which can be downloaded from the d&b website at www.dbaudio.com.



4.5. SERVICE

The SERVICE interface [15] (USB type B connector) allows operating software and loudspeaker configuration updates to be loaded into the unit.

A detailed description of the update procedure is given in the D6 Software manual, which is also provided with the D6.

5. Installation and operation

NOTICE: Observe the operating conditions and limits as given in the technical specifications. Please ensure that ...

- no moisture or liquids can enter the unit, e.g. rain, excessive humidity or steam, oil steam or splashes or knocked over liquids (e.g. Drinks).
- the unit is not exposed to additional heat, e.g. excessive heat from additional equipment or direct sunlight
- no dust or other small particles can enter the unit. In combination with moisture this could lead to malfunction of the unit.

5.1. Rack mounting and cooling

Rack mounting

D6 amplifier enclosures are designed to fit into a standard 19" equipment rack or cabinet.

When specifying a rack, be sure to allow extra depth (100 mm / 4" is usually sufficient) to accommodate the cables and connectors at the rear of the amplifier.

When mounting amplifiers into a 19" rack cabinet, do not just rely on fixing and supporting amplifiers by their front panels. Provide additional support ...

- using shelves fixed to the inner sides of the cabinet or rack
- or the mounting holes provided on the amplifier rear mounted rack ears. This is particularly important if amplifiers are being racked up for touring use.

Cooling

Thermal conditions are a vital factor ensuring operational safety of the power amplifier. The D6 amplifier has an internal fan that draws cool air into the housing from the rear. It expels heated air through the vents on the front panel.

- Please ensure that adequate cool airflow is provided to avoid a build-up of hot air inside the rack leading to overheating. Do not block or cover the rear panel air intake or the vents on the front panel of the amplifier.
- If amplifiers are installed in sealed cabinets (e.g. in fixed installations) use additional fan modules with filters that can be easily replaced without opening the sealed cabinets.

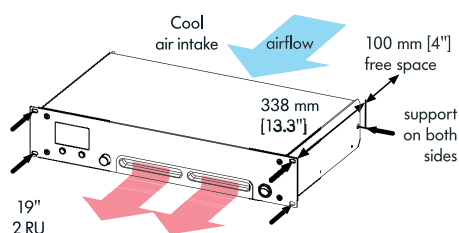

5.2. Operation

5.2.1. Power consumption and power loss

The power required from the mains supply and the waste heat produced by the amplifiers power loss vary depending on the load impedance and the signal levels and characteristics (e.g. speech, music).

In practice, the theoretical peak power consumption of a system will only be sustained for a short period of time. Basing mains current and air conditioning plant requirements on the peak power consumption of the sound system would result in a generously over-specified installation. The key factor in power consumption calculations is the crest factor (CF) of the music or speech signal - the ratio of peak to sustainable RMS voltage of the signal.

A crest factor of 2.4 represents 1/3 of the maximum sine output power and it can be seen as the worst case signal that can be accessed in real world conditions. A proper power distribution should be able to handle the current ratings given in the table below referring to CF 2.4. Using the D6 temporarily with well known signals of higher crest factor, the power distribution can be downsized within the range given in the table.

The table gives power figures for various types of signal waveforms. They were measured on a D6 driving a 4 ohm load (both channels) to the clipping point of both channels using a sine wave burst signal of 24 dBu with a variable duty cycle. The mains power supply used for the measurements supplied an ideal sine wave with 230 V/50 – 60 Hz at an internal resistance of 0.5 ohms (0.12/0.1 ohms for 115/100 V) equivalent to a mains lead of 20 m (65.6 ft) with a cross section of 1.5 mm² (6 mm² / 8 mm² for 115/100 V).

Signal waveform	CF	Duty	P _{out} [W]	P _{in} [W]	P _{loss} [W]	I _{in} [A]	U _{in} [V]	BTU/hr	kCal/hr
Sinus	1.4	1/1	1200	1560	360	6.8	230	1228	310
				1645	445	14.3	115	1518	383
				1715	515	17.2	100	1757	443
Highly compressed music*	2.4	1/3	400	520	120	2.3	230	410	103
				550	150	4.8	115	512	129
				570	170	5.7	100	580	146
Music with low dynamic range	4.0	1/8	150	215	65	1.0	230	222	56
				220	70	2.0	115	239	60
				220	70	2.2	100	239	60

Tab. 4: D6 Power balance

Key:

CF: Crest factor, **Duty:** Duty cycle, **P_{out}[W]:** Max. average output power (sum of both channels), **P_{in}[W]:** Input power (effective power)

P_{loss}: Power loss (thermal power), **I_{in}[A]:** Resulting current, **U_{in}[V]:** Mains voltage

* Maximum practicable operation

5.2.2. Mains supply

The table below indicates the number of devices per phase conductor when full output power is required.

Mains supply	Number of devices
230 V / 16 A	Max. 4
115/100 V / 15 A	Max. 2

In the USA and Japan we recommend the use of mains leads with a high cross section (min. 4 mm² / AWG 12).

5.2.3. Operating conditions

The following diagram shows the thermal operating range within which the technical data will be maintained. The operation beyond this range is possible for a short time and for thermal reasons this will trigger the amplifier protection circuit into thermal overload.

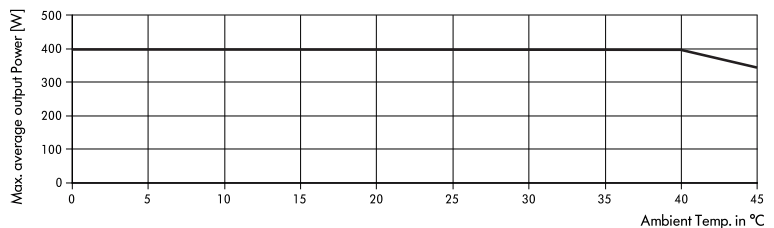

Fig. 7: Average maximum total output power vs. ambient temperature

As explained in section 5.2.1, a worst case signal with a CF of 2.4 is producing 1/3 of the rated sine output power or 200 watts at 4 ohms per channel (400 watts total).

- The thermal management of the D6 is designed to deliver this power for an unlimited amount of time within an ambient temperature of **up to 40° C (104° F)**.
- **With higher ambient temperatures**, the maximum average output power that can be delivered without entering thermal protection, is reducing linearly as shown in the diagram above.
- When using the D6 at its **upper temperature limit of 45° C (113° F)**, the maximum continuous output power is 340 watts total or 170 watts per channel.

Again referring to section 5.2.1 - Tab. 4 - "D6 Power balance" - the unit will work properly with e.g. 150 watts total when either

- running 4 ohms loads when the signal has a CF of 4.0
- or running 8 ohms loads if the worst case signal with a CF of 2.4 needs to be handled.

The maximum possible output power of 2 x 600 W at 4 ohms, which for thermal reasons could only be supplied in short term (within minutes), is unaffected by the ambient temperature.

6. Technical specifications

Displays

ISP A/B.....	Input Signal Present indicator (green)
GR A/B.....	Gain Reduction indicator (yellow)
OVL A/B.....	Overload/Error indicator (red)
MUTE A/B.....	Mute/Standby indicator (green)
Liquid Crystal Display (LCD).....	Graphic display / 120 x 32 Pixel

Controls

POWER.....	Power switch
MUTE A/B.....	Mute /Standby switch
LEVEL/PUSH MENU.....	Digital rotary encoder
access to all functions (Channel A /B) including:	
Level control.....	-57.5 dB to +6 dB with 0.5 dB detents
Input matrix.....	A, B, A+B
Functions.....	Loudspeaker specific circuits CUT/HFA/HFC/CPL
4-band equalizer.....	Optional PEQ/Notch
Delay setting.....	0.3 to 340 ms with 0.1 ms detents
Configurations.....	Current d&b loudspeakers and linear mode
.....	except 2-Way Active, V-Series and B2-SUB setups
Channel coupling.....	common access to Delay, EQ, Delay+EQ
Protection.....	Operator input inhibit /password protection
Remote control.....	CAN-Bus
Device name.....	15 alphanumeric digits
Display illumination.....	Off/On/Timeout 10 s
Frequency generator.....	Pink noise or Sine wave, 10 Hz to 20 kHz
.....	with 1 Hz detents, Level: -57.5 dB to +6 dB with 0.5 dB detents
Buzzer.....	Audible signal for error messages

Monitoring according to IEC 60849

'Sound Systems for Emergency Purposes'

Input monitoring.....	Detecting external Pilot signal
Load monitoring.....	Continuous impedance monitoring
.....	using Pilot signal at 10 Hz and 20 kHz
System check.....	Manual impedance measurement
.....	to calibrate before, and verify after use

Connectors

INPUT ANALOG CH A / CH B.....	XLR 3-pol. female
.....	Pin assignment: 1 = GND, 2 = pos. signal, 3 = neg. signal
Input impedance.....	44 kohms, electronically balanced
Input CMRR, 100 Hz.....	< - 70 dB
Input CMRR, 10 kHz.....	< - 50 dB
Maximum input level.....	+25 dBu
LINK ANALOG CH A / CH B.....	XLR 3-pol. Male
.....	Pin assignment: 1 = GND, 2 = pos. signal, 3 = neg. signal
.....	parallel to input
INPUT DIGITAL AES/EBU.....	XLR 3-pol. female, AES 3
.....	Pin assignment: 1 = GND, 2 = Signal, 3 = Signal
Input impedance.....	110 ohms, transformer balanced
Synchronization.....	Word-Sync: PLL-locked to source (slave mode)
LINK DIGITAL (Output).....	XLR 3-pol. male
.....	electronically balanced
.....	analog signal buffering
.....	power fail relay (Bypass)
.....	Pin assignment: 1 = GND, 2 = Signal, 3 = Signal

OUT A/B.....NL4
Pin assignment: 1+/2+: Output +
1-/2-: Output -
 REMOTE.....2 x RJ 45 parallel
 SERVICE.....USB Typ B

Protection circuits

Mains inrush current limiter.....1.5 A RMS at 230 V
3 A RMS at 115/100 V
 Speaker switch on delay.....Approx. 2 s
 Self-resetting overvoltage protection.....Up to 400 VAC
 Self-resetting overtemperature protection.....75 °C / 167 °F
 Output short circuit protection.....±40 A peak
 Output DC protection.....max. ±10 V

Audio data (linear setting with subsonic filter)

Rated output power (THD+N 0.1 %).....
2 x 350 W into 8 ohms, both channels are driven
2 x 600 W into 4 ohms, both channels are driven
 Frequency response (-3 dB).....28 Hz to 24 kHz
 THD+N (20 Hz - 20 kHz).....< 0.1 %
 IM (SMPTE).....< 0.1 %
 S / N ratio (unweighted, RMS, analog input).....>105 dB
 S / N ratio (unweighted, RMS, digital input).....>110 dB
 Damping factor (20 Hz - 1 kHz / 4 ohms).....>90
 Crosstalk (20 Hz - 20 kHz).....< - 65 dB

Digital Signal Processing

Sampling rate.....96 kHz / 27 Bit ADC / 24 Bit DAC
 Basic delay analog input incl. conversion (AD/DA).....0.3 ms
 Basic delay digital input.....0.22 ms (96 kHz) / 0.45 ms (48 kHz)
 ADC Dynamic.....> 110 dB
 Input Dynamic.....> 127 dB
 DAC Dynamic.....> 110 dB

Power consumption (typical values)

Standby.....4 W
 ON, without signal.....48 W
 ON, Standard signal* at 4 Ohms (2 x 75 W).....215 W
*Standard signal: Pink noise, 1/8 nominal power

Power supply

Switch mode power supply.....
with active power factor correction (PFC)
 Mains connector.....PowerCon® (blue)
 Operating range (min./nom./max.).....85/115/130 V, 50 / 60 Hz
 low range
170/230/266 V, 50 / 60 Hz
 high range
 Mains fuse.....2 x 8 A Time lag (T), internal
 5 x 20 mm, high breaking capacity

Operating conditions

Temperature range*0° C to 40° C / 32° F to 104° F
.....*sum of average output power of 2 x 200 W (400 W)
.....into 4 ohms for continuous operation
Temperature range**0° C to 45° C / 32° F to 113° F
.....**reduced output power or short term operation
Humidity (rel.), average.....< 80 %

Dimensions, weight

Height x width x depth..... 2 RU x 19" x 351 mm
.....2 RU x 19" x 13.8"
Weight.....8 kg / 17.6 lb

6.1. Dimensions

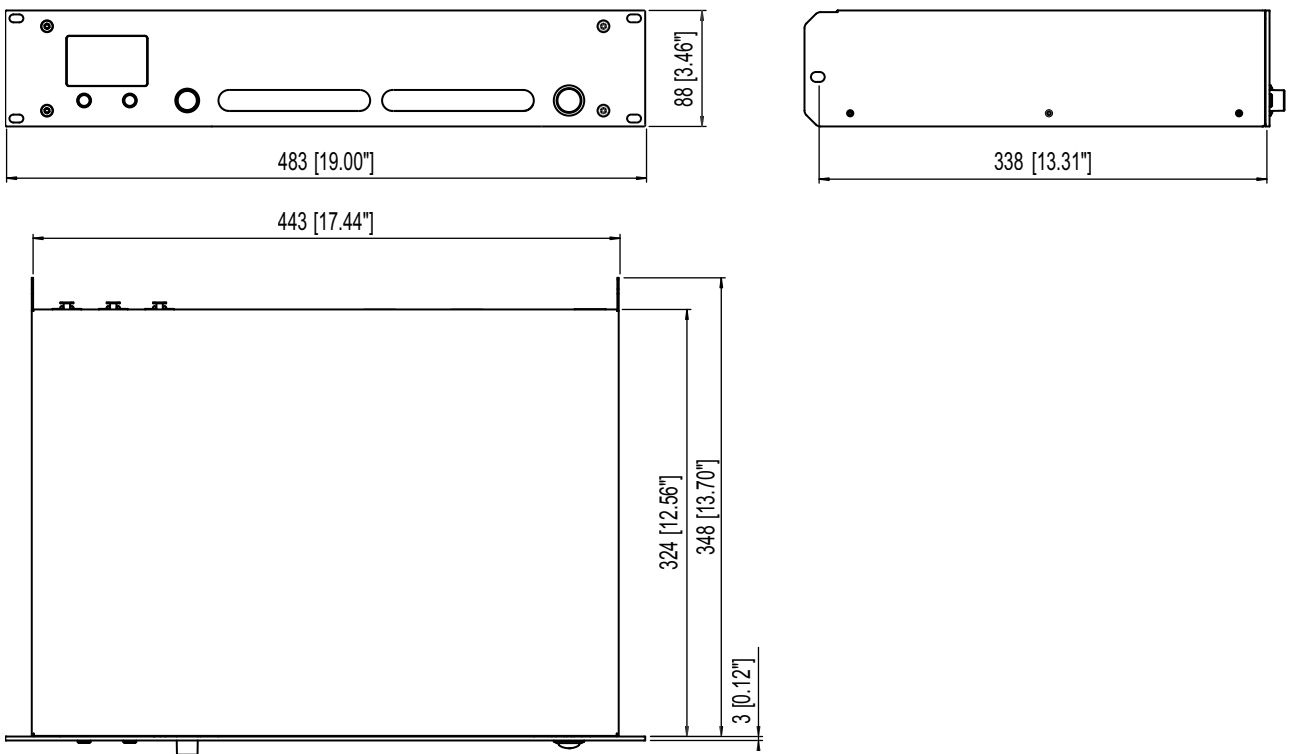

Fig. 8: Dimensions in mm [inch]

7. Manufacturer's declarations



7.1. EU declaration of conformity (CE symbol)

This declaration applies to

- **D6 Amplifier, Z2700**

manufactured by d&b audiotechnik GmbH.

All products of type D6 starting from variant Z2700.000 are included, provided they correspond to the original technical version and have not been subject to any later design or electromechanical modifications.

We herewith declare that said products are in conformity with the provisions of the respective EC directives including all applicable amendments.

A detailed declaration is available on request and can be ordered from d&b or downloaded from the d&b website at www.dbaudio.com.

7.2. WEEE Declaration (Disposal)

Electrical and electronic equipment must be disposed of separately from normal waste at the end of its operational lifetime.

Please dispose of this product according to the respective national regulations or contractual agreements. If there are any further questions concerning the disposal of this product please contact d&b audiotechnik.

