

XS

8S
Manual 1.4 en

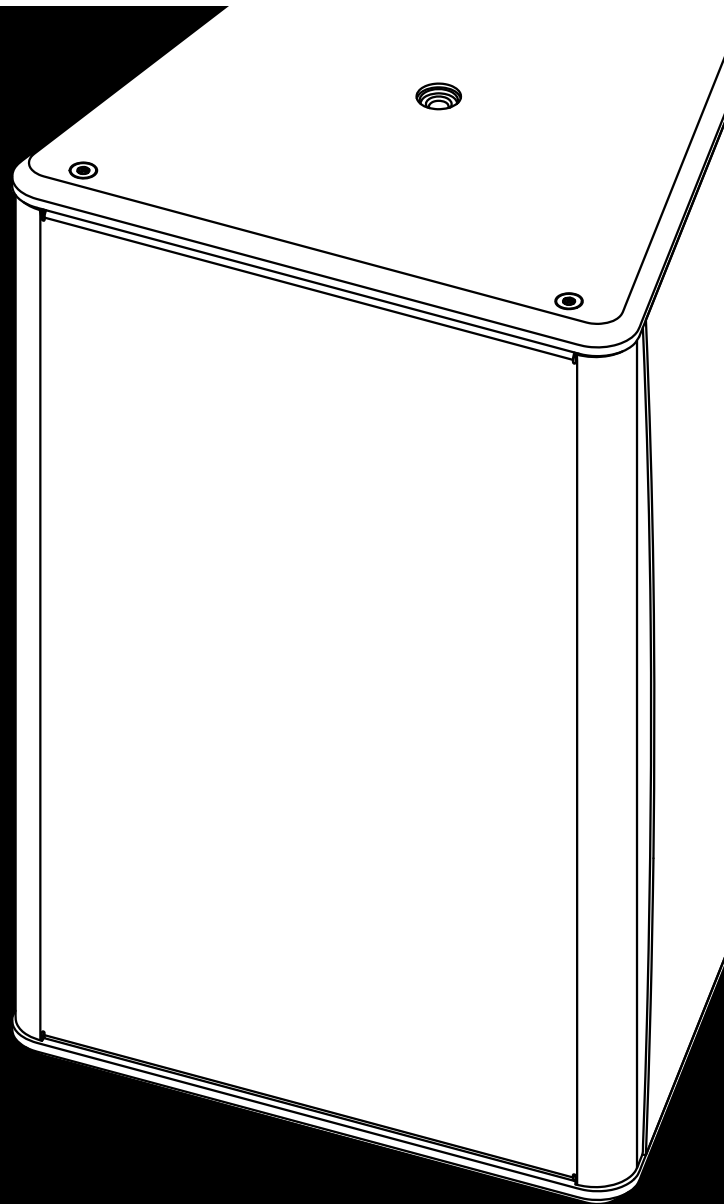

General information

8S Manual

Version: 1.4 en, 10/2018, D2608.EN .01

Copyright © 2018 by d&b audiotechnik GmbH; all rights reserved.

Keep this manual with the product or in a safe place so that it is available for future reference.

When reselling this product, hand over this manual to the new owner.

d&b audiotechnik GmbH
Eugen-Adolff-Straße 134, D-71522 Backnang, Germany
T +49-7191-9669-0, F +49-7191-95 00 00
docadmin@dbaudio.com, www.dbaudio.com

1	Safety precautions	4
1.1	Information regarding the use of loudspeakers.....	4
2	8S loudspeaker	5
2.1	Product description.....	5
2.2	Connections.....	5
2.3	Operation.....	7
2.3.1	Controller settings.....	7
2.4	Dispersion characteristics.....	8
2.5	Technical specifications.....	9
3	Manufacturer's Declarations	10
3.1	EU conformity of loudspeakers (CE symbol).....	10
3.2	WEEE Declaration (Disposal).....	10

1.1 Information regarding the use of loudspeakers

Potential risk of personal injury

Never stand in the immediate vicinity of loudspeakers driven at a high level. Professional loudspeaker systems are capable of causing a sound pressure level detrimental to human health. Seemingly non-critical sound levels (from approx. 95 dB SPL) can cause hearing damage if people are exposed to it over a long period.

In order to prevent accidents when deploying loudspeakers on the ground or when flown, please take note of the following:

- When setting up the loudspeakers or loudspeaker stands, make sure they are standing on a firm surface. If you place several systems on top of one another, use straps to secure them against movement.
- Only use accessories which have been tested and approved by d&b for assembly and mobile deployment. Pay attention to the correct application and maximum load capacity of the accessories as detailed in our specific "Mounting instructions" or in our "Flying system and Rigging manuals".
- Ensure that all additional hardware, fixings and fasteners used for installation or mobile deployment are of an appropriate size and load safety factor. Pay attention to the manufacturers' instructions and to the relevant safety guidelines.
- Regularly check the loudspeaker housings and accessories for visible signs of wear and tear, and replace them when necessary.
- Regularly check all load bearing bolts in the mounting devices.

Potential risk of material damage

Loudspeakers produce a static magnetic field even if they are not connected or are not in use. Therefore make sure when erecting and transporting loudspeakers that they are nowhere near equipment and objects which may be impaired or damaged by an external magnetic field. Generally speaking, a distance of 0.5 m (1.5 ft) from magnetic data carriers (floppy disks, audio and video tapes, bank cards, etc.) is sufficient; a distance of more than 1 m (3 ft) may be necessary with computer and video monitors.

2 8S loudspeaker

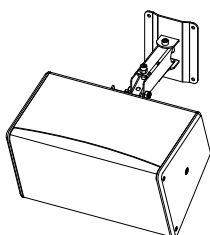
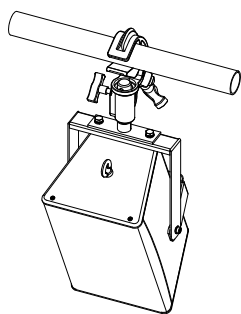
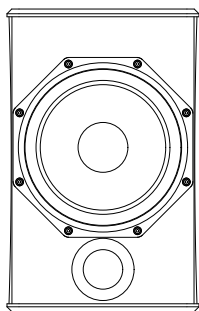

Fig. 1: 8S loudspeaker

Rigging examples:

8S with Z5404 Flying bracket, Z5010 TV spigot and Z5012 Pipe clamp.

8S with Z5403 Wall mount L.

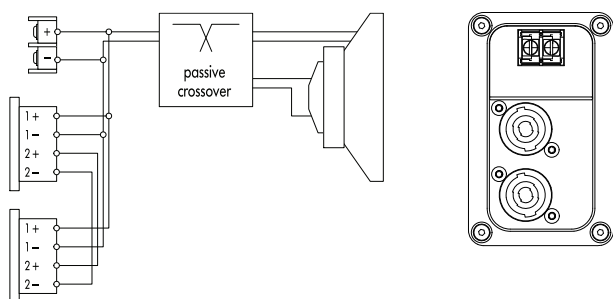

Fig. 2: Connector wiring

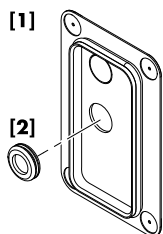

Fig. 3: Cover plate and rubber grommet

2.1 Product description

The 8S loudspeaker is a full range, two-way bass-reflex enclosure, utilizing an 8"/1" coaxial driver combination with a passive crossover. Coaxially mounting the 1" HF compression driver and 8" LF driver using a single magnet assembly creates a very compact driver with 100° constant directivity HF dispersion.

With a frequency response extending from 70 Hz to 20 kHz, the cabinet can be used as a full range system or supplemented by different subwoofers of the xS- or xA-Series.

The enclosure is constructed from marine plywood with an impact resistant black paint finish. The front of the loudspeaker cabinet is protected by a rigid metal grill backed by an acoustically transparent foam.

The 8S rear panel incorporates two M8 threaded inserts to accept the Z5402 Wall mount M, the Z5403 Wall mount L or the Z5404 Flying bracket 8S. The top and bottom panels are each equipped with an M8 thread to accept the Z5408 Horizontal bracket 8S. The threads are covered by dummy caps in cabinet color. The caps must be removed before mounting any accessories.

2.2 Connections

The cabinet is fitted with a pair of NL4 connectors and a two pole screw terminal block (ST - cross-section up to 4 mm²/AWG 11). All four pins of both NL4 connectors are wired in parallel. The cabinet uses the pin assignments 1+/1-. Pins 2+/2- are designated to active subwoofers.

Pin equivalents of the applicable connector options are listed in the table below.

NL4	1+	1-	2+	2-
ST	+	-	n.a.	n.a.

Fixed cable connection

The 8S loudspeaker is supplied with a cover plate [1] and a rubber grommet feed through [2]. For indoor operation, these items can be used to hide the connector panel, if required. For unprotected outdoor operation, the connector panel must be covered, i.e. both items must be used to achieve an IP degree of protection of IP34.

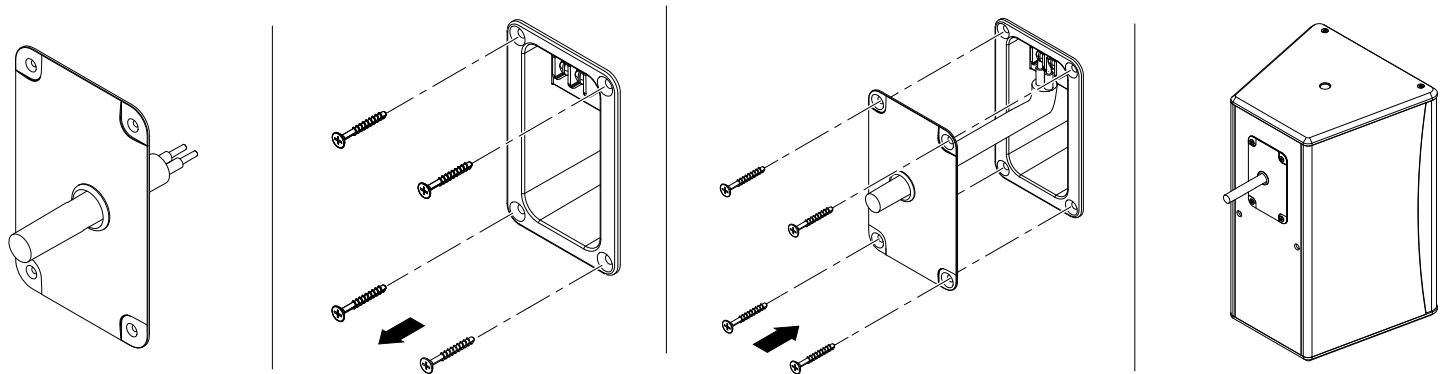

Fig. 4: Installing the fixed cable connection

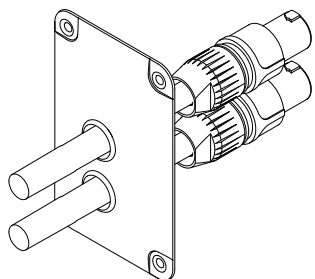

Fig. 5: NL4 cable connection with cover plate [1]

To install the fixed cable connection, proceed as follows:

Tools required: Philips screw driver (#PH2).

1. Prepare the rubber grommet and the connection cable.
2. Remove the knockout opening in the cover plate and attach the rubber grommet correspondingly.
3. Insert the connection cable through the rubber grommet and connect the cable wires to the screw terminal.
⇒ Observe the correct polarity!
4. Undo the four screws of the connector panel.
5. Push the cover plate towards the connector panel until it fits into place.
6. Finally fix the cover plate together with the connector panel using the four screws.

NL4 connection with cover plate

The two NL4 connector sockets of the cabinet's connector panel are located in a recess to allow the use of the cover plate [1] together with NL4 cable connectors, as shown in the graphic opposite.

Note: Neutrik NL4FC type connectors must be used for this option.

The cover plate is equipped with two knockout openings to allow daisy chaining of the loudspeaker.

To use the NL4 connection, proceed in the same manner as described above in the section entitled ⇒ "Fixed cable connection" on page 5.

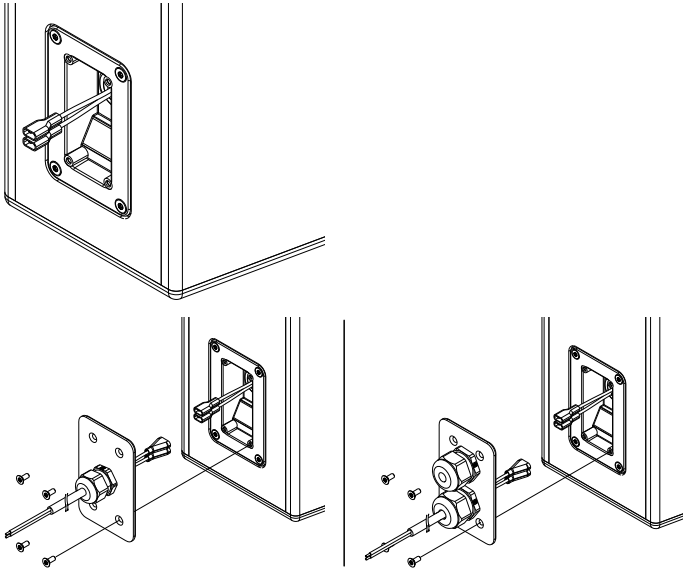

WR option (Weather Resistance)

WR cabinets are equipped with a recessed connector panel including a Faston type connector (2 x 6,3 mm, female). A cover plate which accepts single or dual PG cable glands (Type PG13.5 for cable diameters from 6 - 12 mm) is enclosed, as shown in the graphic opposite.

To install the fixed connection cable, please proceed as follows:

Tools required: Screw driver (T20).

Note: Observe the correct polarity of the cable
Brown (+) / Blue (-).

1. Insert the connection cable through the PG screwing and connect the male connector to the female connector.
2. Push the cover plate towards the connector panel until it fits into place.
3. Fix the cover plate to the connector panel using the four countersunk screws.

2.3 Operation

NOTICE!

Only operate d&b loudspeakers with a correctly configured d&b amplifier, otherwise there is a risk of damaging the loudspeaker components.

Applicable d&b amplifiers:

10D/30D/D6/D12/D20/D80.

Application	Setup	Cabinets per channel
8S	8S	4

Within applicable d&b amplifiers, the controller setup is available in Dual Channel or Mix TOP/SUB mode.

2.3.1 Controller settings

For acoustic adjustment the functions CUT, HFA and CPL can be selected.

CUT circuit

Set to CUT, the cabinet low frequency level is reduced. The cabinet is now configured for use with d&b active subwoofers.

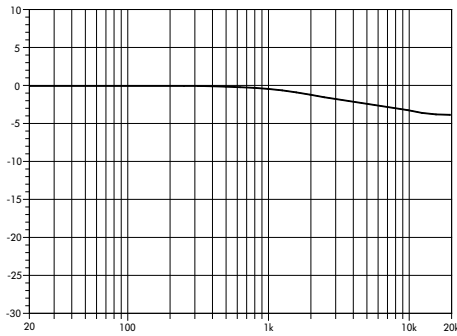

Fig. 6: Frequency response correction of HFA circuit

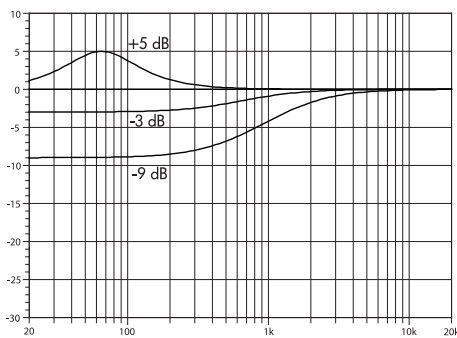

Fig. 7: Frequency response correction of CPL circuit

HFA circuit

In HFA mode (High Frequency Attenuation), the HF response of the system is rolled off. HFA provides a natural, balanced frequency response when a unit is placed close to listeners in near field or delay use.

High Frequency Attenuation begins gradually at 1 kHz, dropping by approximately 3 dB at 10 kHz. This roll off mimics the decline in frequency response experienced when listening to a system from a distance in a typically reverberant room or auditorium.

CPL circuit

The CPL (Coupling) circuit compensates for coupling effects between the cabinets when building closely coupled arrays. CPL begins gradually around 1 kHz, with the maximum attenuation below 200 Hz. To achieve a balanced frequency response, the CPL circuit can be set to dB attenuation values between 0 and -9.

Positive CPL values create an adjustable low frequency boost (0 to +5 dB) and can be set when the system is used in full range mode without subwoofers.

2.4 Dispersion characteristics

The following graph shows dispersion angle over frequency of a single cabinet plotted using lines of equal sound pressure (isobars) at -6 dB and -12 dB

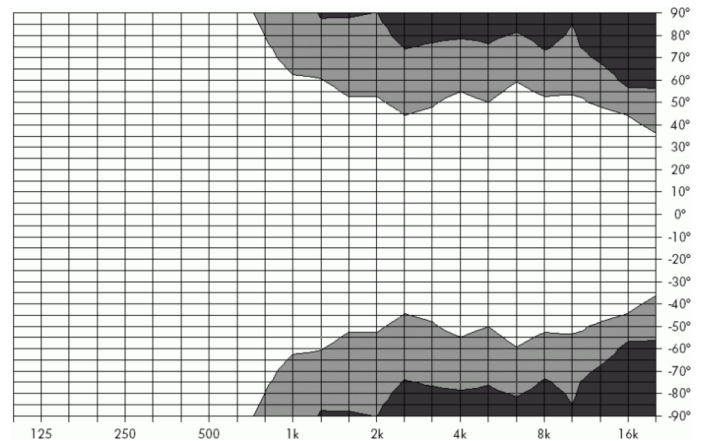

Fig. 8: Isobar diagram horizontal and vertical

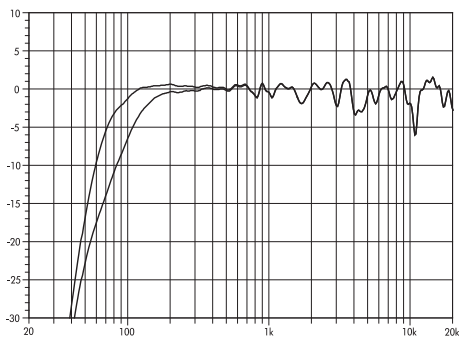

Fig. 9: 8S frequency response, standard and CUT modes

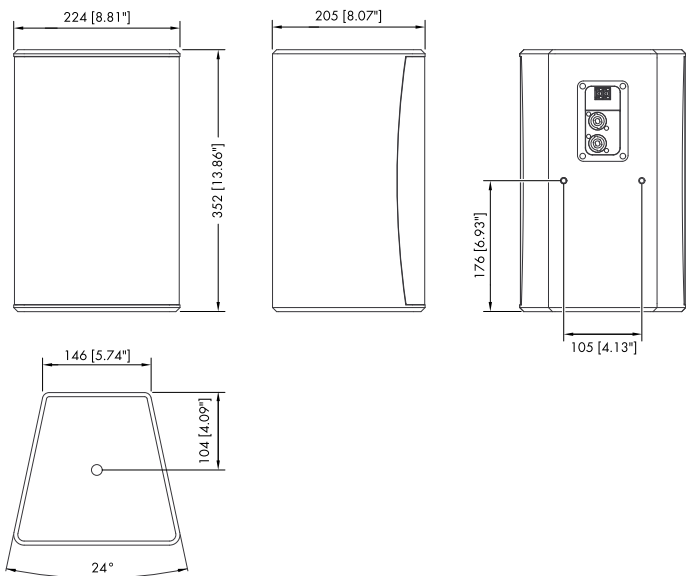

Fig. 10: 8S cabinet dimensions in mm [inch]

2.5 Technical specifications

8S system data

Frequency response (-5 dB standard)	70 Hz - 20 kHz
Frequency response (-5 dB CUT mode)	110 Hz - 20 kHz
Max. sound pressure (1 m, free field)	
with 10D/D6	124 dB
with 30D/D20/D12	127 dB
with D80	127 dB
	(SPLmax peak, pink noise test signal with crest factor of 4)

8S loudspeaker

Nominal impedance	16 ohms
Power handling capacity (RMS/peak 10 ms)	150/800 W
Nominal dispersion angle (hor. x vert.)	100° conical
Components	8" driver with neodymium magnet
	1" compression driver, coaxially mounted
	Passive crossover network
Connections	2 x NL4
	1 x screw terminal (ST - up to 4 mm ² /AWG 11)
Optional fixed cable (PG):	
	H07-RN-F, 2 x 2.5 mm ² (AWG 13), 5.5 m (18 ft)
Pin assignments	NL4: 1+/1-
	Fixed cable (PG): Brown + / Blue -
Weight	7.4 kg (16 lb)



3.1 EU conformity of loudspeakers (CE symbol)

This declaration applies to:

d&b 8S loudspeaker, Z1540/Z1617

manufactured by d&b audiotechnik GmbH.

All production versions of these types are included, provided they correspond to the original technical version and have not been subject to any later design or electromechanical modifications.

We herewith declare that said products are in conformity with the provisions of the respective EC directives including all applicable amendments.

A detailed declaration is available on request and can be ordered from d&b or downloaded from the d&b website at www.dbaudio.com.

3.2 WEEE Declaration (Disposal)

Electrical and electronic equipment must be disposed of separately from normal waste at the end of its operational lifetime.

Please dispose of this product according to the respective national regulations or contractual agreements. If there are any further questions concerning the disposal of this product, please contact d&b audiotechnik.



